

**NICHIA CORPORATION**

## **SPECIFICATIONS FOR WHITE LED**

### **NFCWL060B-V3**

- Built-in ESD Protection Device
- RoHS Compliant



## SPECIFICATIONS

### (1) Absolute Maximum Ratings

Item	Symbol	Absolute Maximum Rating	Unit
Forward Current	$I_F$	1000	mA
Pulse Forward Current	$I_{FP}$	1500	mA
Allowable Reverse Current	$I_R$	85	mA
Power Dissipation	$P_D$	36	W
Operating Temperature	$T_{opr}$	-40~105	°C
Storage Temperature	$T_{sta}$	-40~100	°C
Junction Temperature	$T_J$	140	°C

\* Absolute Maximum Ratings at  $T_J=25^{\circ}\text{C}$ .

\*  $I_{FP}$  conditions with pulse width  $\leq 10\text{ms}$  and duty cycle  $\leq 10\%$ .

\* For  $I_F$  and  $I_{FP}$ , see the "DERATING CHARACTERISTICS" of this specification.

\* The operating Temperature ( $T_{opr}$ ) range is the range of case temperatures.

(2) Initial Electrical/Optical Characteristics

Item		Symbol	Condition	Typ	Max	Unit
Forward Voltage		$V_F$	$I_F=460\text{mA}$	34.8	-	V
R70	Luminous Flux (Chromaticity Coordinate1)	$\Phi_v$	$I_F=460\text{mA}$	2920	-	lm
	Color Rendering Index (Chromaticity Coordinate1)	$R_a$	$I_F=460\text{mA}$	73	-	-
R8000	Luminous Flux (Chromaticity Coordinate1)	$\Phi_v$	$I_F=460\text{mA}$	2680	-	lm
	Color Rendering Index (Chromaticity Coordinate1)	$R_a$	$I_F=460\text{mA}$	83	-	-
R9050	Luminous Flux (Chromaticity Coordinate1)	$\Phi_v$	$I_F=460\text{mA}$	2310	-	lm
	Color Rendering Index (Chromaticity Coordinate1)	$R_a$	$I_F=460\text{mA}$	93	-	-
R95	Luminous Flux (Chromaticity Coordinate1)	$\Phi_v$	$I_F=460\text{mA}$	1910	-	lm
	Color Rendering Index (Chromaticity Coordinate1)	$R_a$	$I_F=460\text{mA}$	98	-	-
Chromaticity Coordinate1	x	-	$I_F=460\text{mA}$	0.4338	-	-
	y	-	$I_F=460\text{mA}$	0.4030	-	-
R70	Luminous Flux (Chromaticity Coordinate2)	$\Phi_v$	$I_F=460\text{mA}$	3000	-	lm
	Color Rendering Index (Chromaticity Coordinate2)	$R_a$	$I_F=460\text{mA}$	73	-	-
R8000	Luminous Flux (Chromaticity Coordinate2)	$\Phi_v$	$I_F=460\text{mA}$	2830	-	lm
	Color Rendering Index (Chromaticity Coordinate2)	$R_a$	$I_F=460\text{mA}$	83	-	-
R9050	Luminous Flux (Chromaticity Coordinate2)	$\Phi_v$	$I_F=460\text{mA}$	2490	-	lm
	Color Rendering Index (Chromaticity Coordinate2)	$R_a$	$I_F=460\text{mA}$	93	-	-
R95	Luminous Flux (Chromaticity Coordinate2)	$\Phi_v$	$I_F=460\text{mA}$	2170	-	lm
	Color Rendering Index (Chromaticity Coordinate2)	$R_a$	$I_F=460\text{mA}$	98	-	-
Chromaticity Coordinate2	x	-	$I_F=460\text{mA}$	0.3447	-	-
	y	-	$I_F=460\text{mA}$	0.3553	-	-
Thermal Resistance		$R_{\theta JC}$	-	1.4	1.7	$^{\circ}\text{C}/\text{W}$

\* Characteristics at  $T_J=25^{\circ}\text{C}$  and measured in pulse mode.

\* Optical Characteristics as per CIE 127:2007 standard.

\* Chromaticity Coordinates as per CIE 1931 Chromaticity Chart.

\*  $R_{\theta JC}$  is measured using the Dynamic Mode detailed in JESD51-1.

\*  $R_{\theta JC}$  is the thermal resistance from the junction to the  $T_C$  measurement point.

RANKS

Item	Rank	Condition	Min	Max	Unit
Forward Voltage	-	I <sub>F</sub> =460mA	33.6	36.0	V
Luminous Flux	Q0270	I <sub>F</sub> =460mA	2700	3320	lm
	Q0268		2680	3280	
	Q0266		2660	3260	
	Q0262		2620	3220	
	Q0258		2580	3160	
	Q0257		2570	3150	
	Q0254		2540	3120	
	Q0253		2530	3110	
	Q0252		2520	3080	
	Q0248		2480	3040	
	Q0241		2410	2950	
	Q0233		2330	2850	
	Q0226		2260	2780	
	Q0224		2240	2740	
	Q0221		2210	2710	
	Q0220		2200	2700	
	Q0216		2160	2660	
	Q0207		2070	2530	
	Q0202		2020	2480	
	Q0199		1990	2450	
	Q0198		1980	2420	
	Q0195		1950	2390	
	Q0190		1900	2340	
	Q0188		1880	2300	
Q0187	1870	2290			
Q0182	1820	2240			
Q0171	1710	2090			
Q0170	1700	2080			
Q0160	1600	1960			
Color Rendering Index	R70	R <sub>a</sub>	70	-	-
	R8000	R <sub>a</sub>	80	-	
		R <sub>9</sub>	0	-	
	R9050	R <sub>a</sub>	90	-	
		R <sub>9</sub>	50	-	
R95	R <sub>a</sub>	95	-		

Color Ranks(I<sub>F</sub>=460mA)

The color ranks have chromaticity ranges within 2-step MacAdam ellipse.

		Rank sm222	Rank sm252	Rank sm272	Rank sm302	Rank sm352	Rank sm402
Color Temperature (Unit: K)	T <sub>CP</sub>	2200	2500	2700	3000	3500	4000
Center Point	x	0.5018	0.4806	0.4578	0.4338	0.4073	0.3818
	y	0.4153	0.4141	0.4101	0.4030	0.3917	0.3797
Minor Axis	a	0.002668	0.002686	0.002704	0.002738	0.002732	0.002714
Major Axis	b	0.004804	0.005010	0.005248	0.005594	0.005864	0.006188
Ellipse Rotation Angle	Φ	-39.89	-37.58	-36.05	-36.00	-35.47	-35.95

		Rank sm452	Rank sm502	Rank sm572	Rank sm652
Color Temperature (Unit: K)	T <sub>CP</sub>	4500	5000	5700	6500
Center Point	x	0.3611	0.3447	0.3287	0.3123
	y	0.3658	0.3553	0.3417	0.3282
Minor Axis	a	0.002568	0.002370	0.002058	0.001806
Major Axis	b	0.006006	0.005612	0.005206	0.004374
Ellipse Rotation Angle	Φ	-34.33	-31.78	-31.56	-32.35

The color ranks have chromaticity ranges within 3-step MacAdam ellipse.

		Rank sm223	Rank sm253	Rank sm273	Rank sm303	Rank sm353	Rank sm403
Color Temperature (Unit: K)	T <sub>CP</sub>	2200	2500	2700	3000	3500	4000
Center Point	x	0.5018	0.4806	0.4578	0.4338	0.4073	0.3818
	y	0.4153	0.4141	0.4101	0.4030	0.3917	0.3797
Minor Axis	a	0.004002	0.004029	0.004056	0.004107	0.004098	0.004071
Major Axis	b	0.007206	0.007515	0.007872	0.008391	0.008796	0.009282
Ellipse Rotation Angle	Φ	-39.89	-37.58	-36.05	-36.00	-35.47	-35.95

		Rank sm453	Rank sm503	Rank sm573	Rank sm653
Color Temperature (Unit: K)	T <sub>CP</sub>	4500	5000	5700	6500
Center Point	x	0.3611	0.3447	0.3287	0.3123
	y	0.3658	0.3553	0.3417	0.3282
Minor Axis	a	0.003852	0.003555	0.003087	0.002709
Major Axis	b	0.009009	0.008418	0.007809	0.006561
Ellipse Rotation Angle	Φ	-34.33	-31.78	-31.56	-32.35

- \* Ranking at T<sub>J</sub>=25°C and measured in pulse mode.
- \* Forward Voltage Tolerance: ±0.35V
- \* Luminous Flux Tolerance: ±5%
- \* Color Rendering Index R<sub>a</sub> Tolerance: ±2
- \* Color Rendering Index R<sub>9</sub> Tolerance: ±6.5
- \* The R<sub>9</sub> value for the above rank shall be greater than 0.
- \* Chromaticity Coordinate Tolerance: ±0.005
- \* LEDs from the above ranks will be shipped. The rank combination ratio per shipment will be decided by Nichia.

Luminous Flux Ranks by Color Rank, Color Rendering Index Rank

Color Coordinates	Color Rendering Index	Luminous Flux
sm222,sm223	R8000	Q0207
	R9050	Q0170
sm252,sm253	R8000	Q0220
	R9050	Q0188
sm272,sm273	R70	Q0257
	R8000	Q0233
	R9050	Q0199
	R95	Q0160
sm302,sm303	R70	Q0262
	R8000	Q0241
	R9050	Q0207
	R95	Q0171
sm352,sm353	R70	Q0268
	R8000	Q0248
	R9050	Q0216
	R95	Q0182
sm402,sm403	R70	Q0270
	R8000	Q0253
	R9050	Q0221
	R95	Q0187
sm452,sm453	R70	Q0270
	R8000	Q0258
	R9050	Q0226
	R95	Q0190
sm502,sm503	R70	Q0270
	R8000	Q0254
	R9050	Q0224
	R95	Q0195
sm572,sm573	R70	Q0266
	R8000	Q0254
	R9050	Q0226
	R95	Q0198
sm652,sm653	R70	Q0266
	R8000	Q0252
	R9050	Q0226
	R95	Q0202

CHROMATICITY DIAGRAM

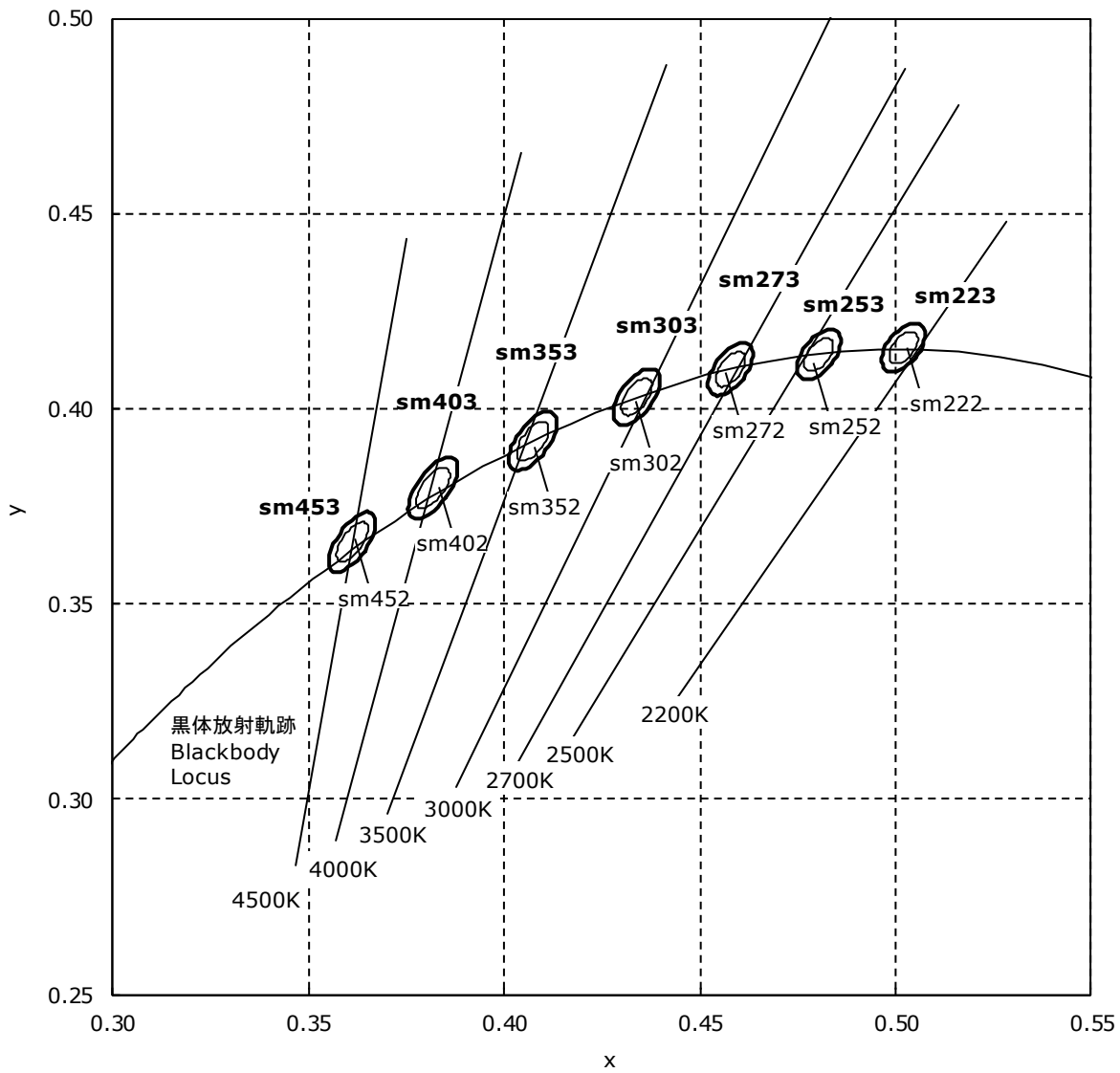

CHROMATICITY DIAGRAM

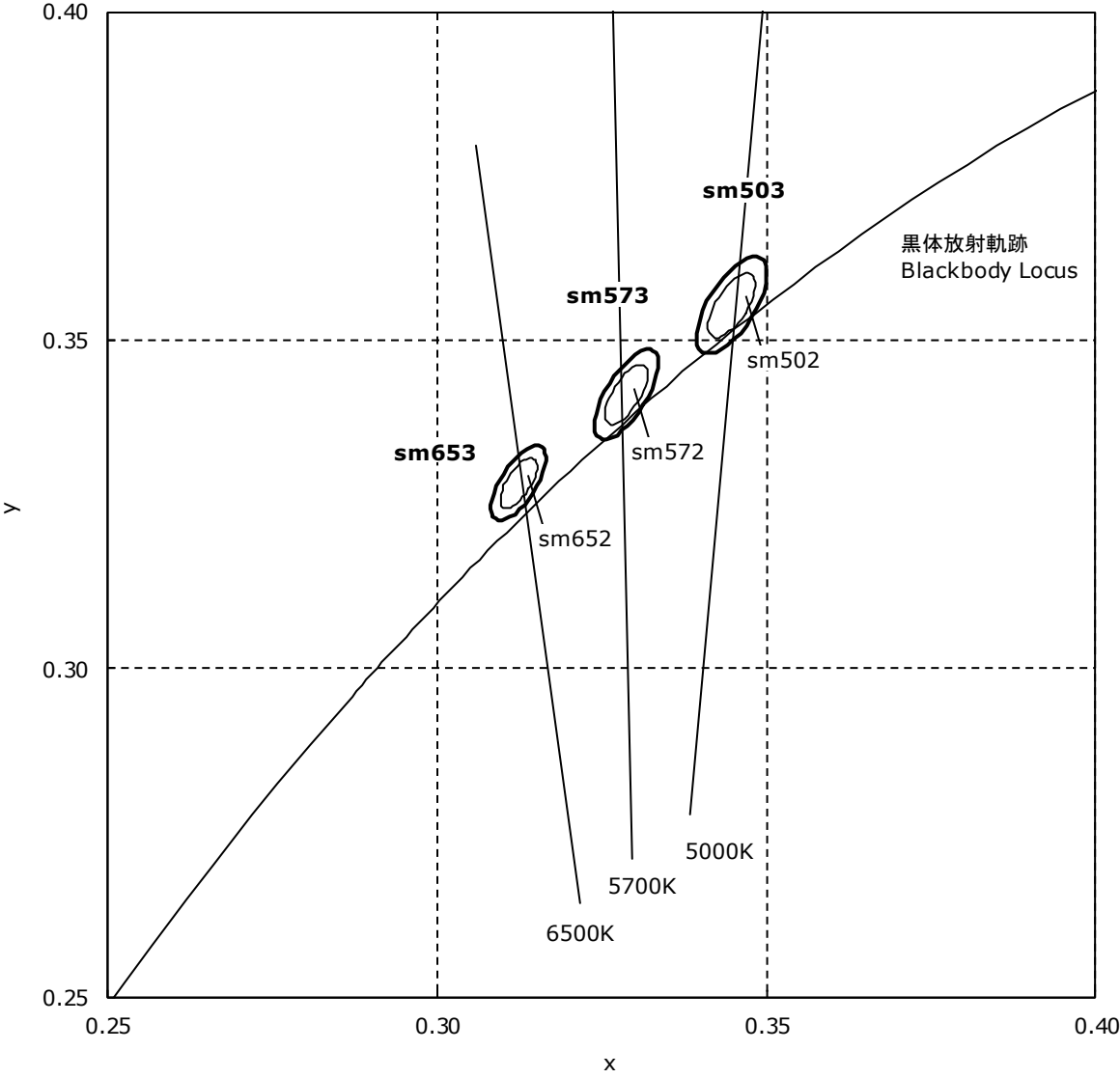

# OUTLINE DIMENSIONS

\* 本製品はRoHS指令に適合しております。  
This product complies with RoHS Directive.

NFCWL060B-Vx  
管理番号 No. STS-DA7-10874A

\* 括弧で囲まれた寸法は参考値です。  
The dimension(s) in parentheses are for reference purposes.

(単位 Unit: mm, 公差 Tolerance: ±0.3)

光学的中心位置  
Location of the optical center  
発光部中心の位置精度 ±0.3mm  
The center of emitting area to be centered ±0.3mm.

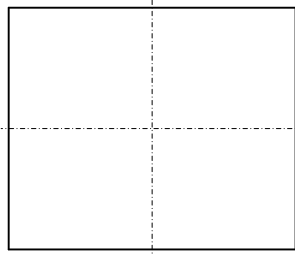
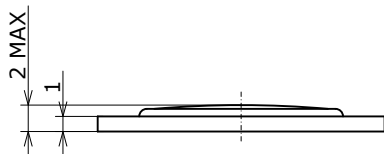
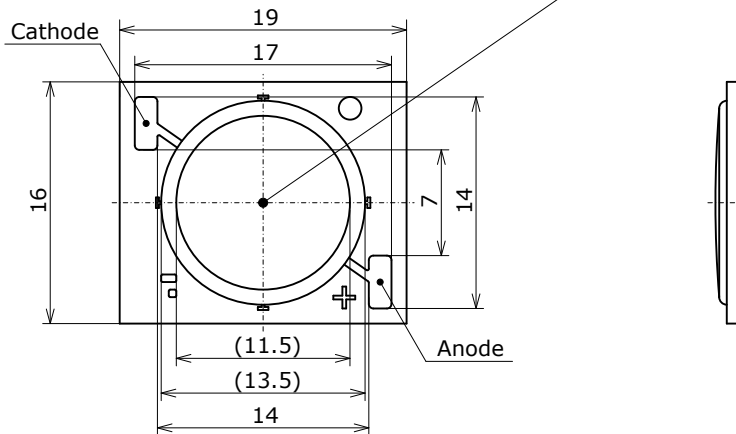

項目 Item	内容 Description
パッケージ材質 Package Materials	セラミックス Ceramics
封止樹脂材質 Encapsulating Resin Materials	シリコン樹脂 (拡散剤+蛍光体入り) Silicone Resin (with diffuser and phosphor)
電極材質 Electrodes Materials	金メッキ Au-plated
質量 Weight	1.2g(TYP)

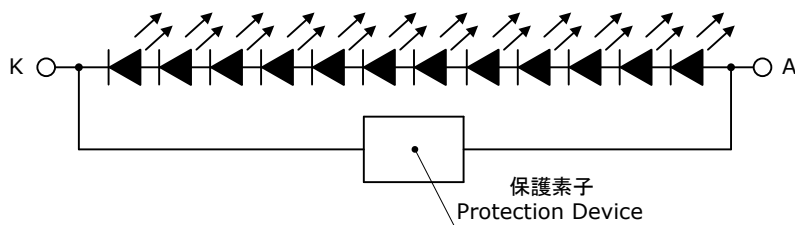

## SOLDERING

- Recommended Hand Soldering Condition

Temperature	380°C Max
Soldering Time	5sec Max

- \* Hand soldering must not be performed more than once.
- \* This LED uses a silicone resin for the encapsulating resin frame or resin area; the silicone resin is soft. If excess pressure is applied to the silicone resin, it may cause the resin to be damaged, chipped, cracked and/or deformed. If the encapsulating resin frame and/or resin area are damaged, chipped, cracked and/or deformed, it may cause the wire to break causing a catastrophic failure (i.e. the LED not to illuminate) and/or reliability issues (e.g. the LED to corrode and/or to become dimmer, the color directivity to change, etc.).
- \* Repairing should not be done after the LEDs have been soldered. It should be confirmed beforehand whether the characteristics of the LEDs will or will not be damaged by repairing.
- \* When soldering, do not apply stress to the LED while the LED is hot.
- \* When using an automatic pick-and-place machine, choose an appropriate nozzle for this LED. Using a pick-and-place nozzle with a smaller diameter than the size of the LED's emitting surface will cause damage to the emitting surface causing a catastrophic failure (i.e. the LED not to illuminate).
- \* When flux is used, it should be a halogen free flux. Ensure that the manufacturing process is not designed in a manner where the flux will come in contact with the LEDs.
- \* During and/or after soldering an electric wire to the electrode, ensure that tension is not applied to the electric wire. This may cause the electrode to be damaged and/or reduce the adhesive strength of the electrode to the package.
- \* If soldering is used to join electric wires to the electrodes, the adhesive strength of the electrode to the package may be reduced depending on the substances that are found in the solder paste and/or the type of the wire cover that is used. Ensure that there are no issues with the materials that will be used in the chosen application prior to use.

# TRAY DIMENSIONS

\* 数量は1トレイにつき 54個入りです。  
 Tray Size: 54pcs

NxxxL060x  
 管理番号 No. STS-DA7-5899

\* 寸法は参考です。  
 All dimensions shown are for reference only and are not guaranteed.

(単位 Unit: mm)

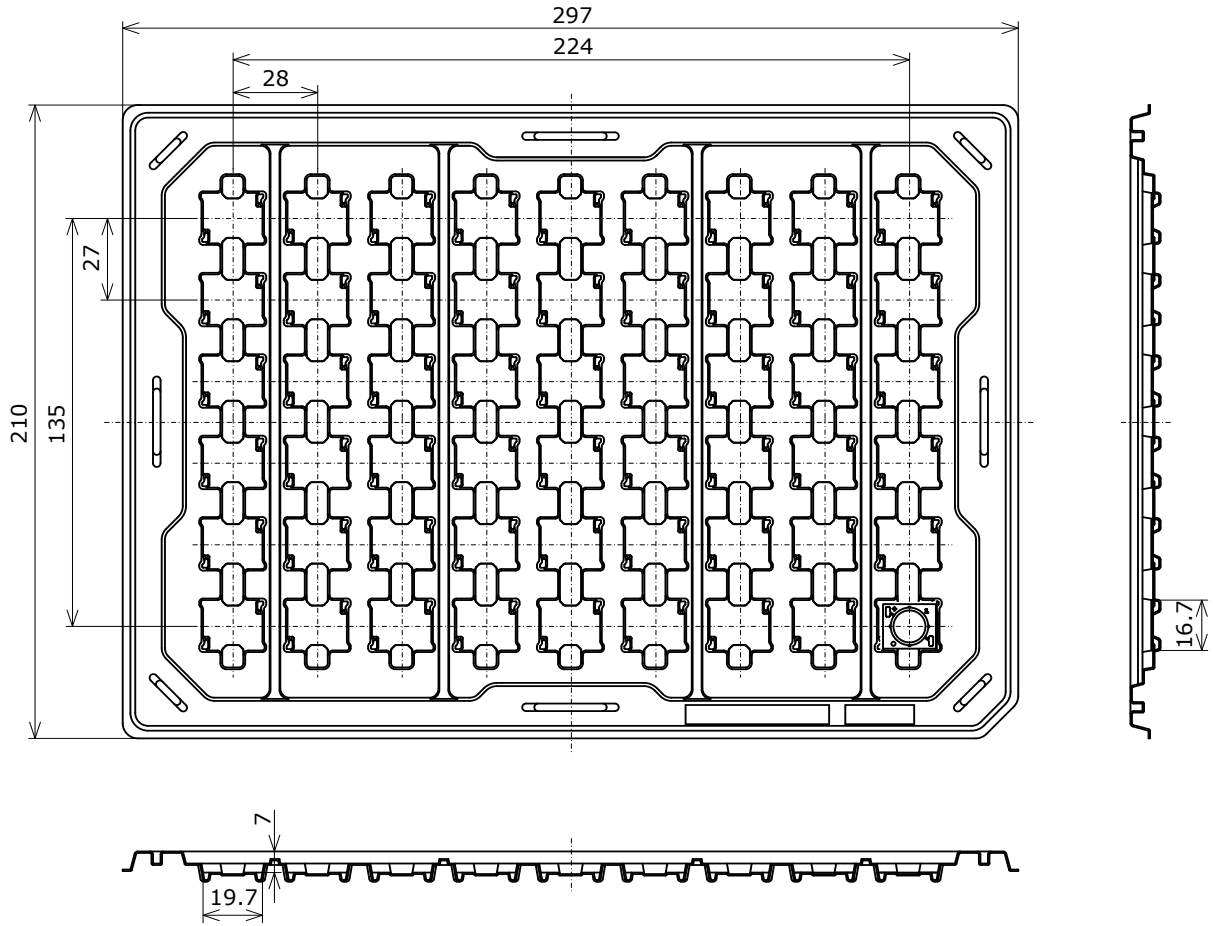

## PACKAGING - TRAY PACK

シリカゲルとともにトレイをアルミ防湿袋に入れ、熱シールにより封をします。  
Trays are shipped with desiccants in heat-sealed moisture-proof bags.

Nxxxxxxx  
管理番号 No. STS-DA7-5106

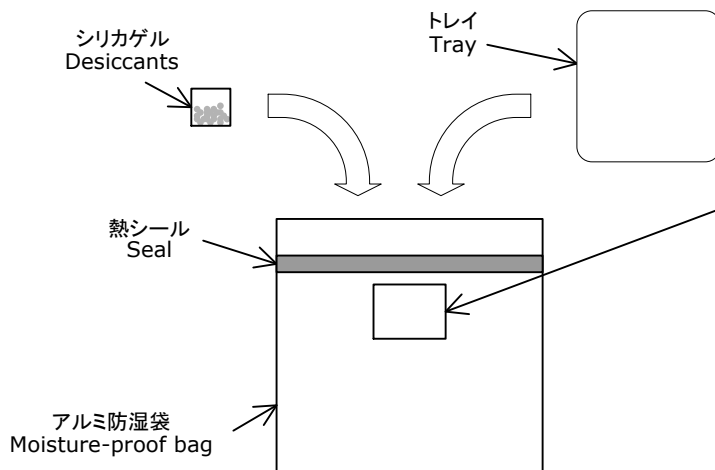

ラベル Label

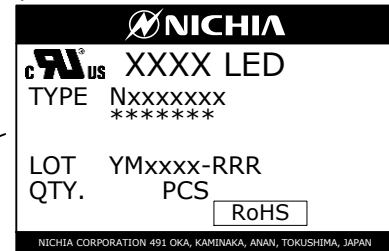

アルミ防湿袋を並べて入れ、ダンボールで仕切ります。  
Moisture-proof bags are packed in cardboard boxes with corrugated partitions.

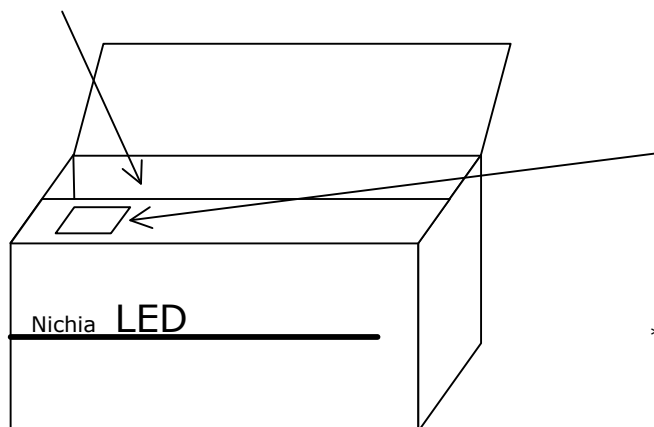

ラベル Label



- \* 客先型名を\*\*\*\*\*で示します。  
客先型名が設定されていない場合は空白です。  
\*\*\*\*\* is the customer part number.  
If not provided, it will not be indicated on the label.
- \* ロット表記方法についてはロット番号の項を参照して下さい。  
For details, see "LOT NUMBERING CODE" in this document.

- \* 本製品はトレイに入れたのち、輸送の衝撃から保護するためダンボールで梱包します。  
Products shipped on trays are packed in a moisture-proof bag.  
They are shipped in cardboard boxes to protect them from external forces during transportation.
- \* 取り扱いに際して、落下させたり、強い衝撃を与えたりしますと、製品を損傷させる原因になりますので注意して下さい。  
Do not drop or expose the box to external forces as it may damage the products.
- \* ダンボールには防水加工がされておりませんので、梱包箱が水に濡れないよう注意して下さい。  
Do not expose to water. The box is not water-resistant.
- \* 輸送、運搬に際して弊社よりの梱包状態あるいは同等の梱包を行って下さい。  
Using the original package material or equivalent in transit is recommended.

## LOT NUMBERING CODE

Lot Number is presented by using the following alphanumeric code.

YMxxxx - RRR

Y - Year

Year	Y
2016	G
2017	H
2018	I
2019	J
2020	K
2021	L

M - Month

Month	M	Month	M
1	1	7	7
2	2	8	8
3	3	9	9
4	4	10	A
5	5	11	B
6	6	12	C

xxxx-Nichia's Product Number

RRR-Ranking by Color Coordinates, Ranking by Luminous Flux, Ranking by Color Rendering Index

# DERATING CHARACTERISTICS

NFCWL060B-V3  
 管理番号 No. STS-DA7-12949

## ケース温度測定部温度-許容順電流特性

Temperature at Measure Point on a Case vs Allowable Forward Current

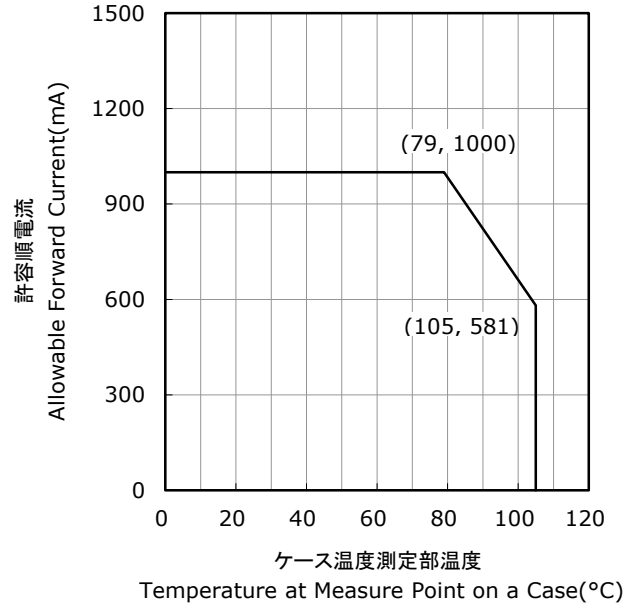

## デューティー比-許容順電流特性

Duty Ratio vs Allowable Forward Current

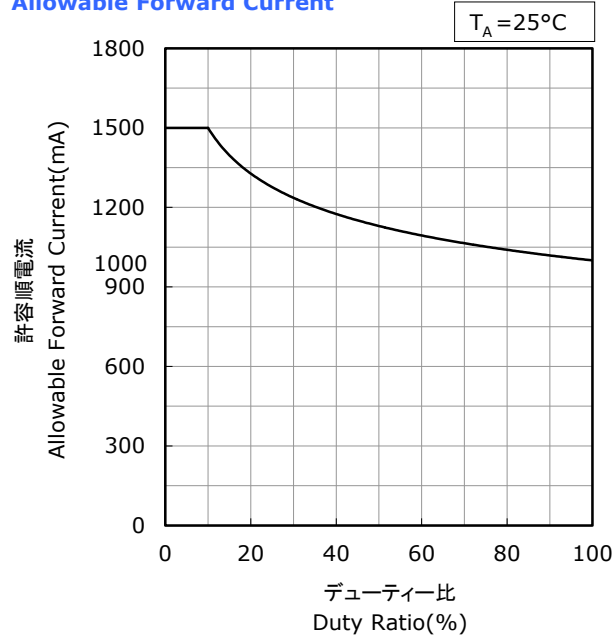

# OPTICAL CHARACTERISTICS

- \* 本特性は参考です。  
All characteristics shown are for reference only and are not guaranteed.
- \* パルス駆動により測定しています。  
The following graphs show the characteristics measured in pulse mode.

NFCWL060B-V3  
管理番号 No. STS-DA7-12950

## 発光スペクトル Spectrum

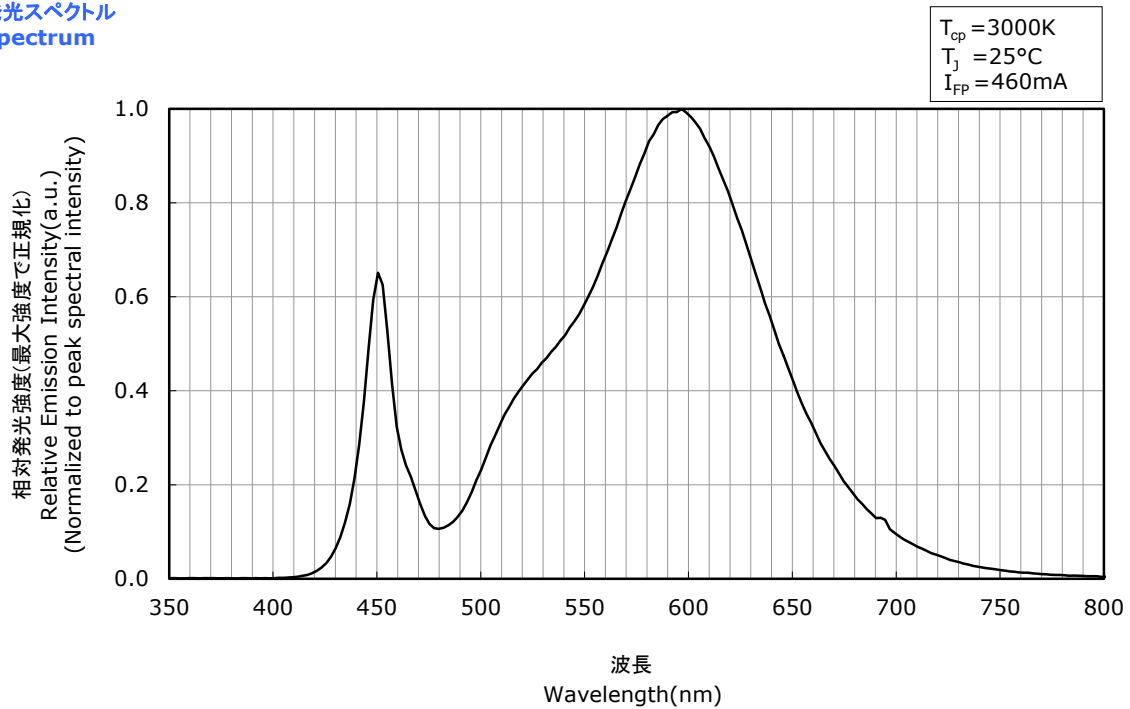

## 指向特性 Directivity

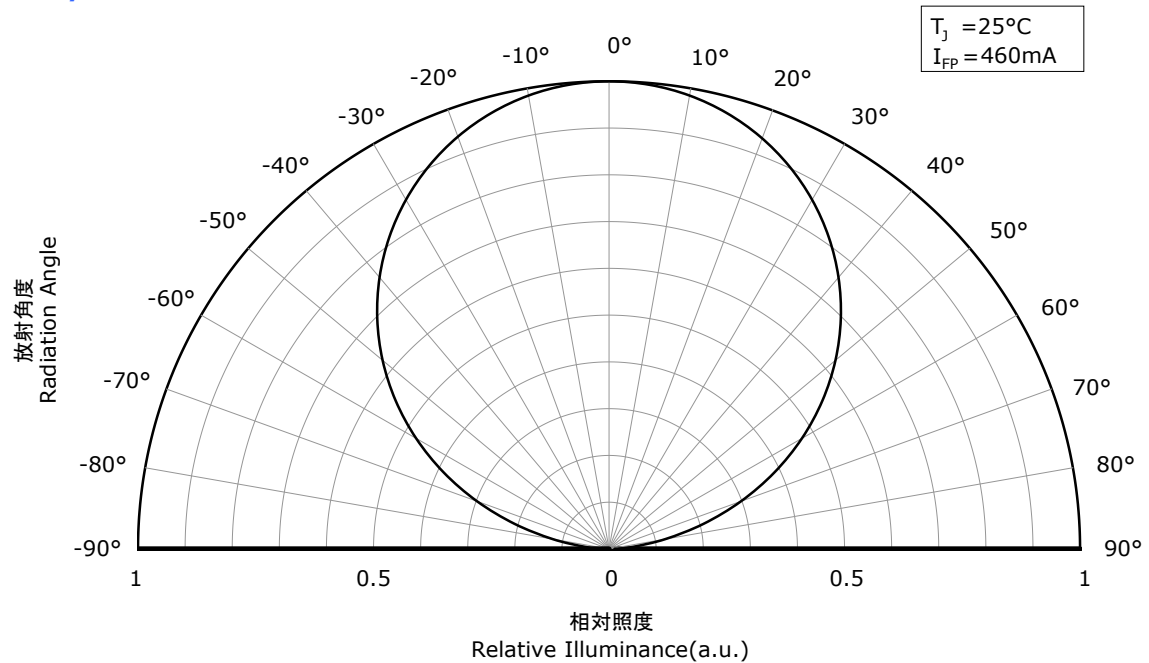

- \* 本特性は演色性ランクR70に対応しています。  
The graphs above show the characteristics for R70 LEDs of this product.

# OPTICAL CHARACTERISTICS

- \* 本特性は参考です。  
All characteristics shown are for reference only and are not guaranteed.
- \* パルス駆動により測定しています。  
The following graphs show the characteristics measured in pulse mode.

NFCWL060B-V3  
管理番号 No. STS-DA7-12951

## 発光スペクトル Spectrum

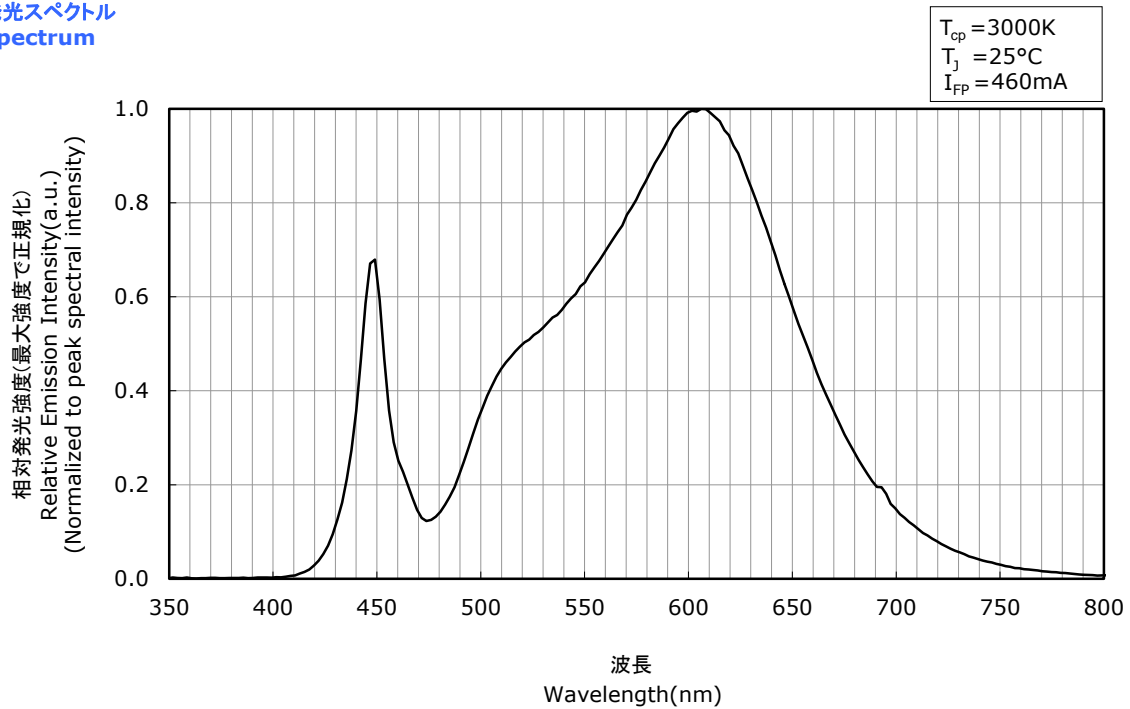

## 指向特性 Directivity

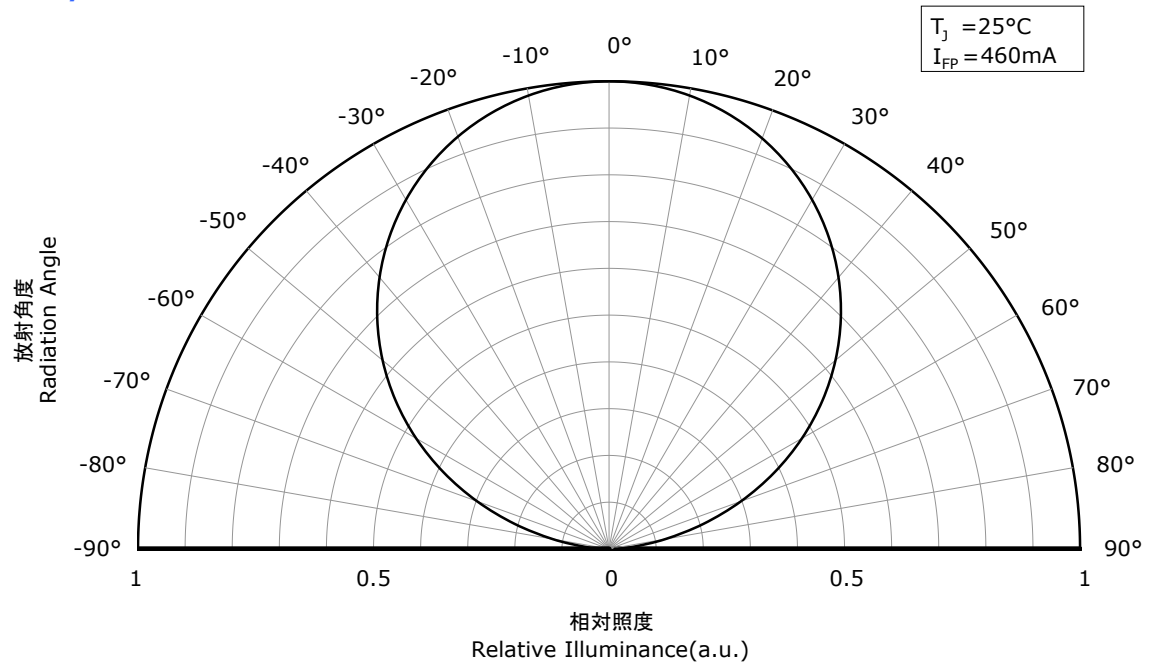

- \* 本特性は演色性ランクR8000に対応しています。  
The graphs above show the characteristics for R8000 LEDs of this product.

# OPTICAL CHARACTERISTICS

- \* 本特性は参考です。  
All characteristics shown are for reference only and are not guaranteed.
- \* パルス駆動により測定しています。  
The following graphs show the characteristics measured in pulse mode.

NFCWL060B-V3  
管理番号 No. STS-DA7-12952

## 発光スペクトル Spectrum

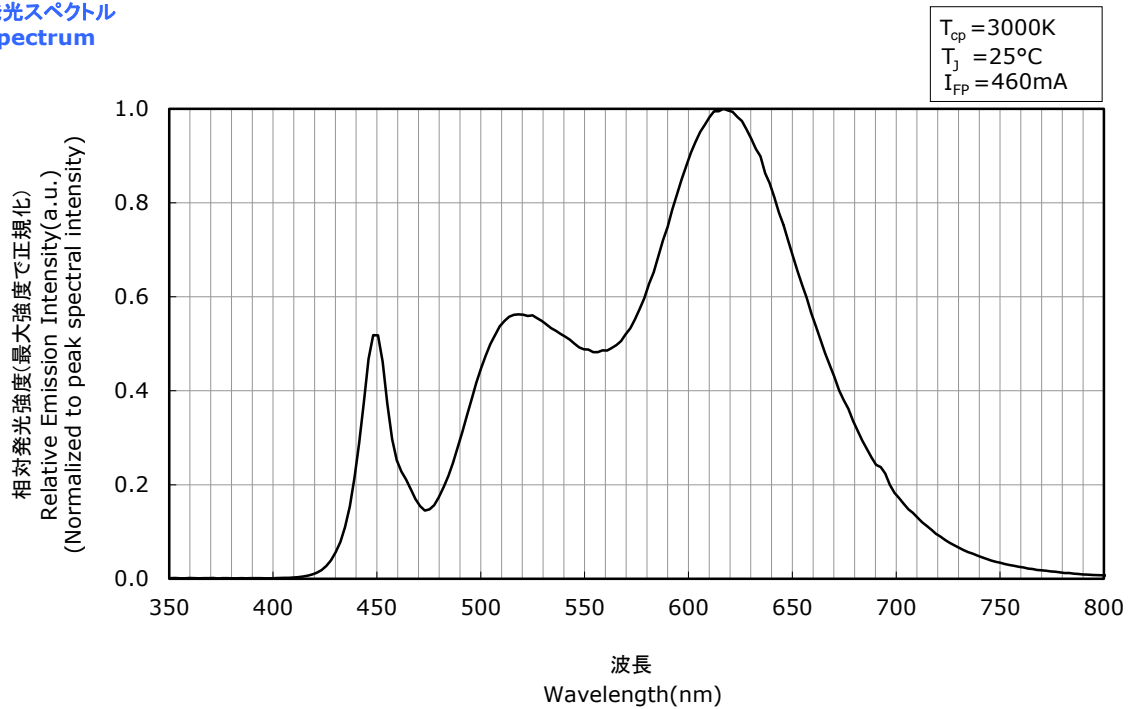

## 指向特性 Directivity

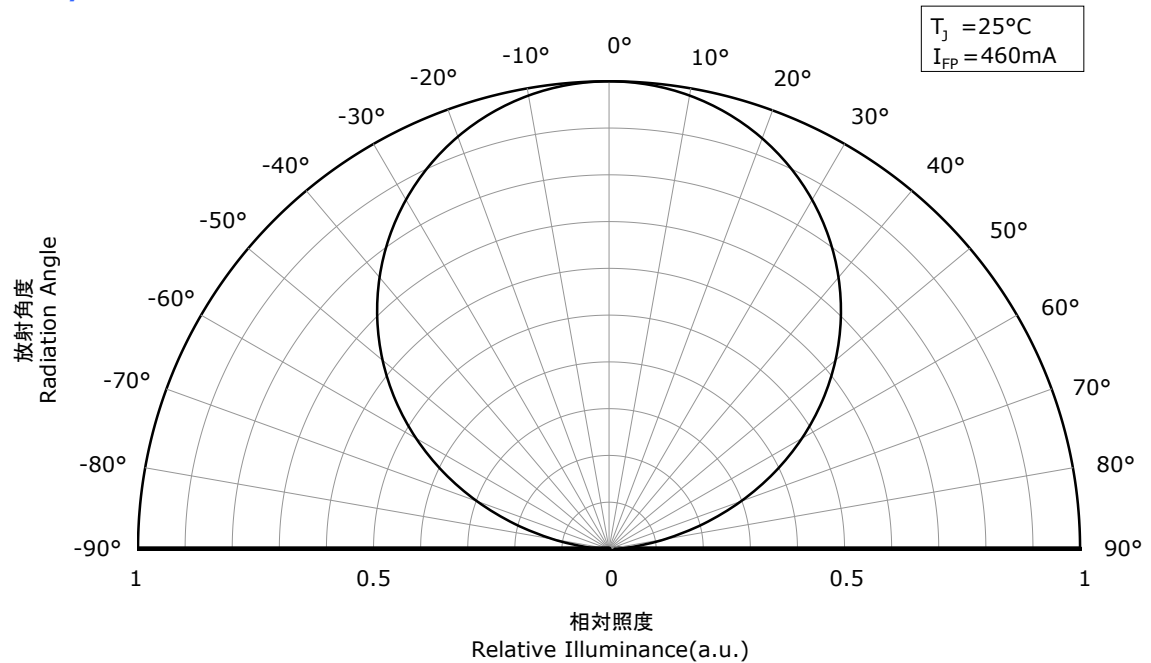

- \* 本特性は演色性ランクR9050に対応しています。  
The graphs above show the characteristics for R9050 LEDs of this product.

# OPTICAL CHARACTERISTICS

- \* 本特性は参考です。  
All characteristics shown are for reference only and are not guaranteed.
- \* パルス駆動により測定しています。  
The following graphs show the characteristics measured in pulse mode.

NFCWL060B-V3  
管理番号 No. STS-DA7-12953

## 発光スペクトル Spectrum

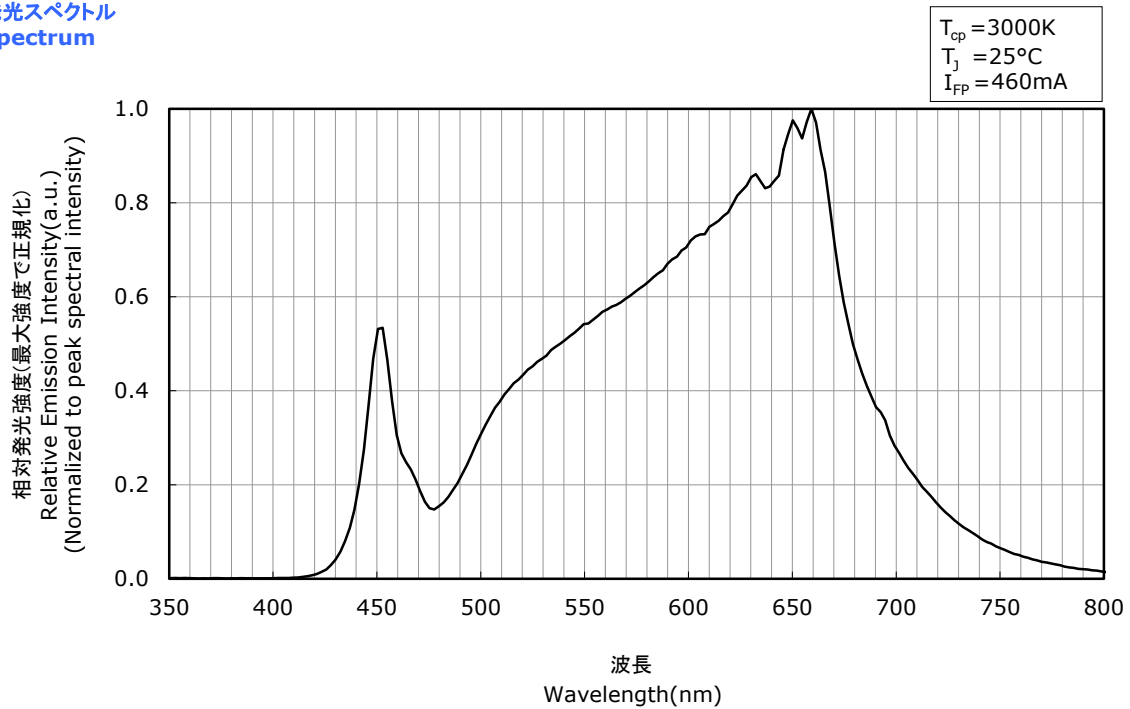

## 指向特性 Directivity

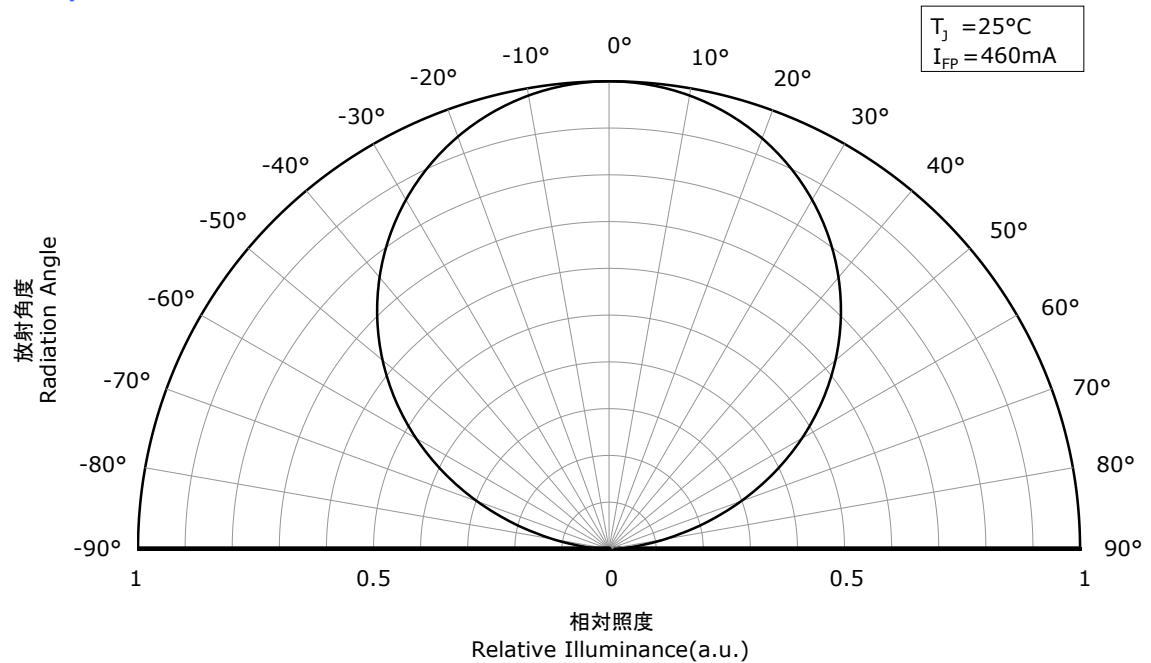

- \* 本特性は演色性ランクR95に対応しています。  
The graphs above show the characteristics for R95 LEDs of this product.

# OPTICAL CHARACTERISTICS

- \* 本特性は参考です。  
All characteristics shown are for reference only and are not guaranteed.
- \* パルス駆動により測定しています。  
The following graphs show the characteristics measured in pulse mode.

NFCWL060B-V3  
管理番号 No. STS-DA7-12954

## 発光スペクトル Spectrum

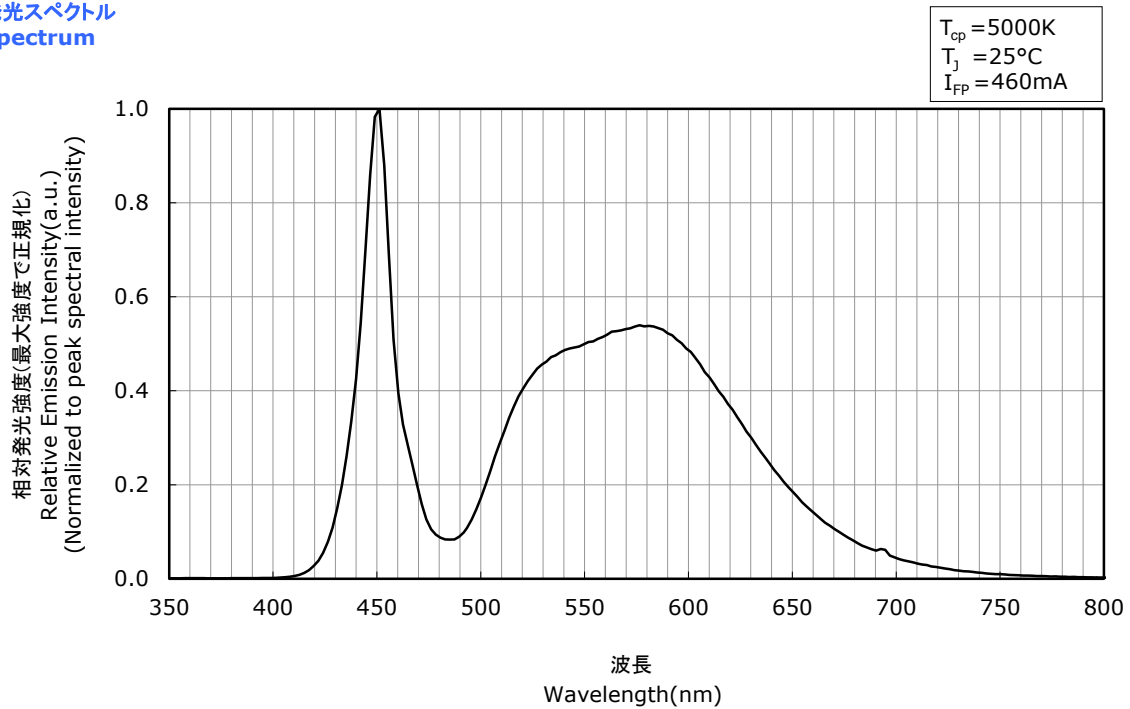

## 指向特性 Directivity

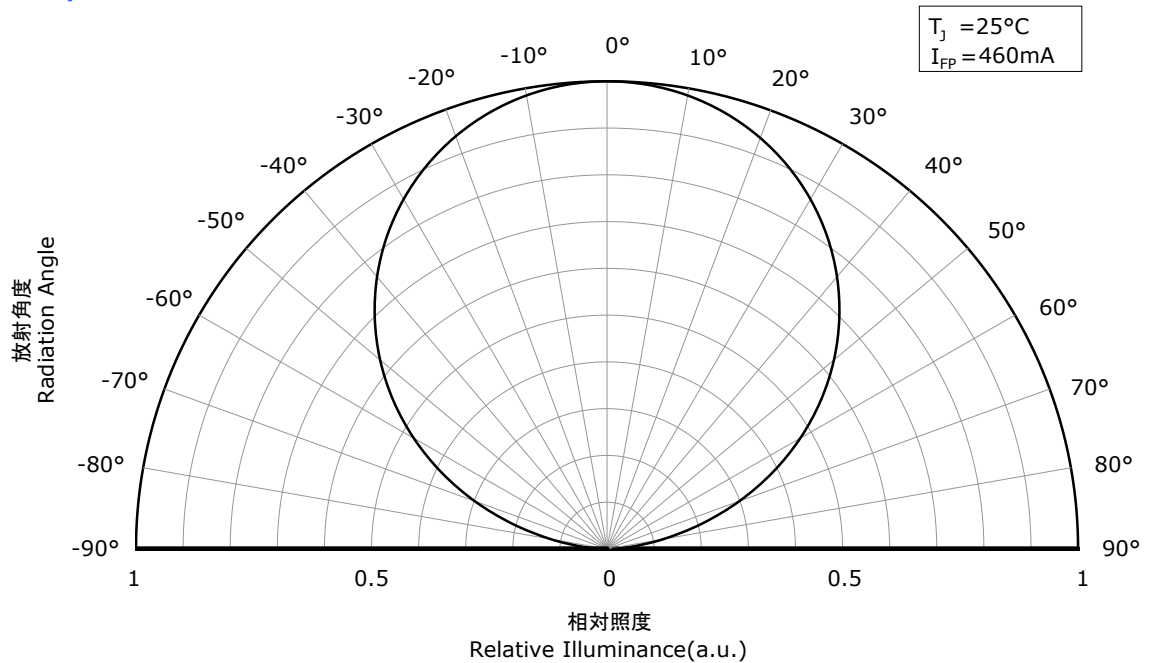

- \* 本特性は演色性ランクR70に対応しています。  
The graphs above show the characteristics for R70 LEDs of this product.

# OPTICAL CHARACTERISTICS

- \* 本特性は参考です。  
All characteristics shown are for reference only and are not guaranteed.
- \* パルス駆動により測定しています。  
The following graphs show the characteristics measured in pulse mode.

NFCWL060B-V3  
管理番号 No. STS-DA7-12955

## 発光スペクトル Spectrum

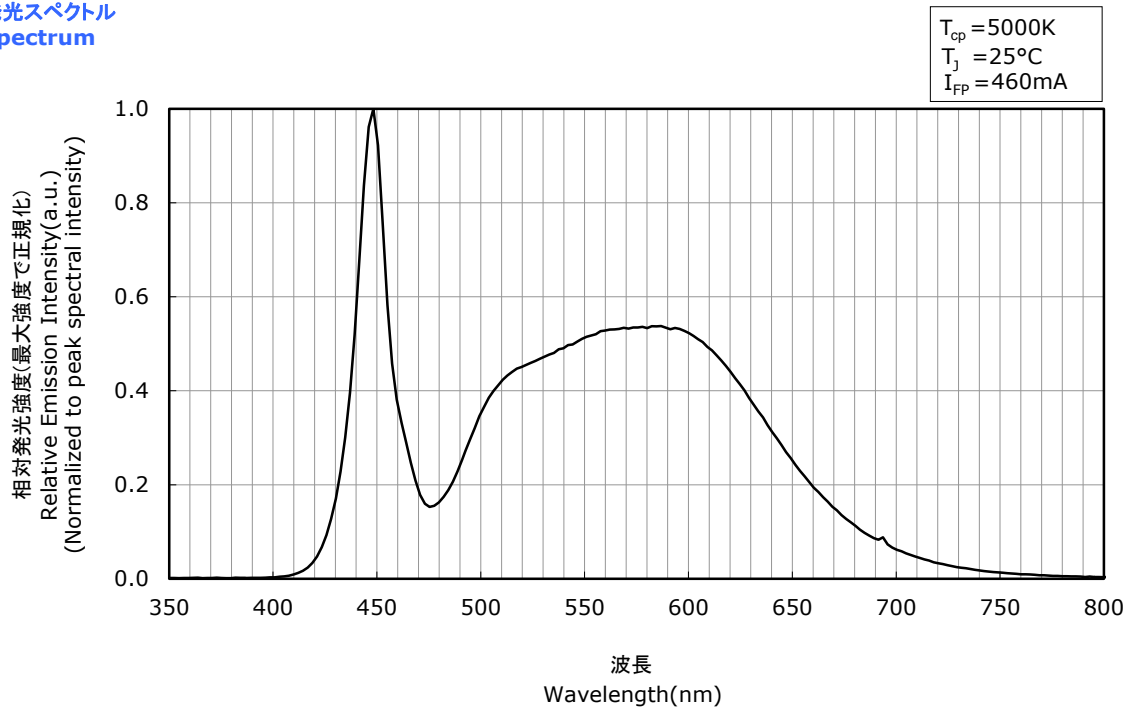

## 指向特性 Directivity

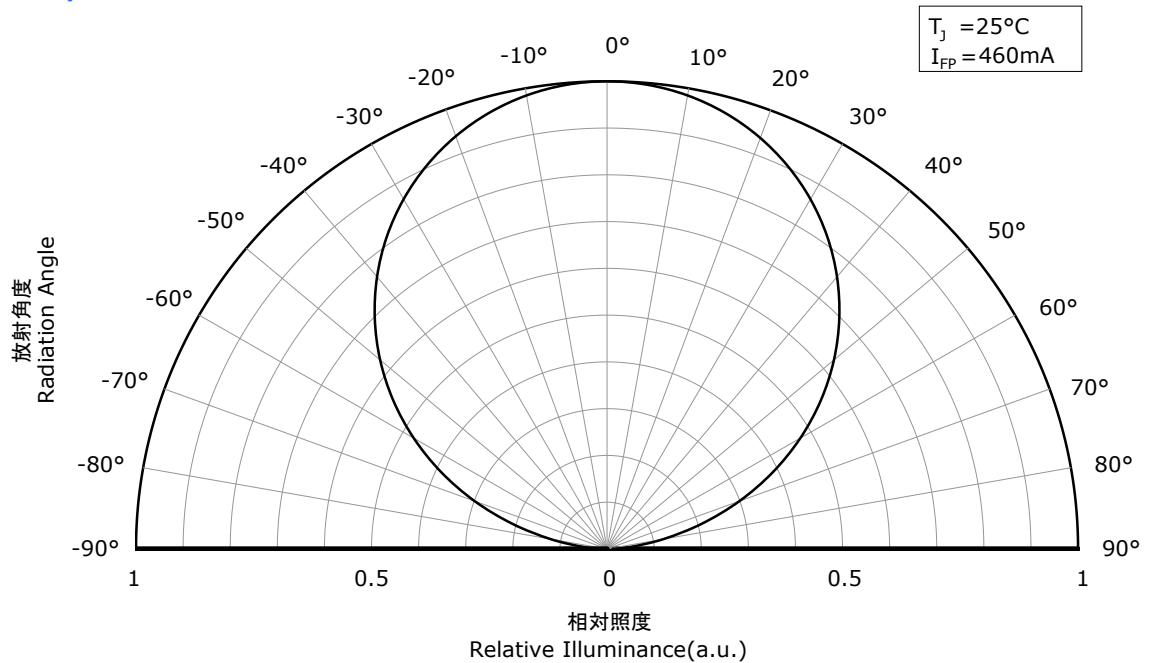

- \* 本特性は演色性ランクR8000に対応しています。  
The graphs above show the characteristics for R8000 LEDs of this product.

## OPTICAL CHARACTERISTICS

- \* 本特性は参考です。  
All characteristics shown are for reference only and are not guaranteed.
- \* パルス駆動により測定しています。  
The following graphs show the characteristics measured in pulse mode.

NFCWL060B-V3  
管理番号 No. STS-DA7-12956

### 発光スペクトル Spectrum

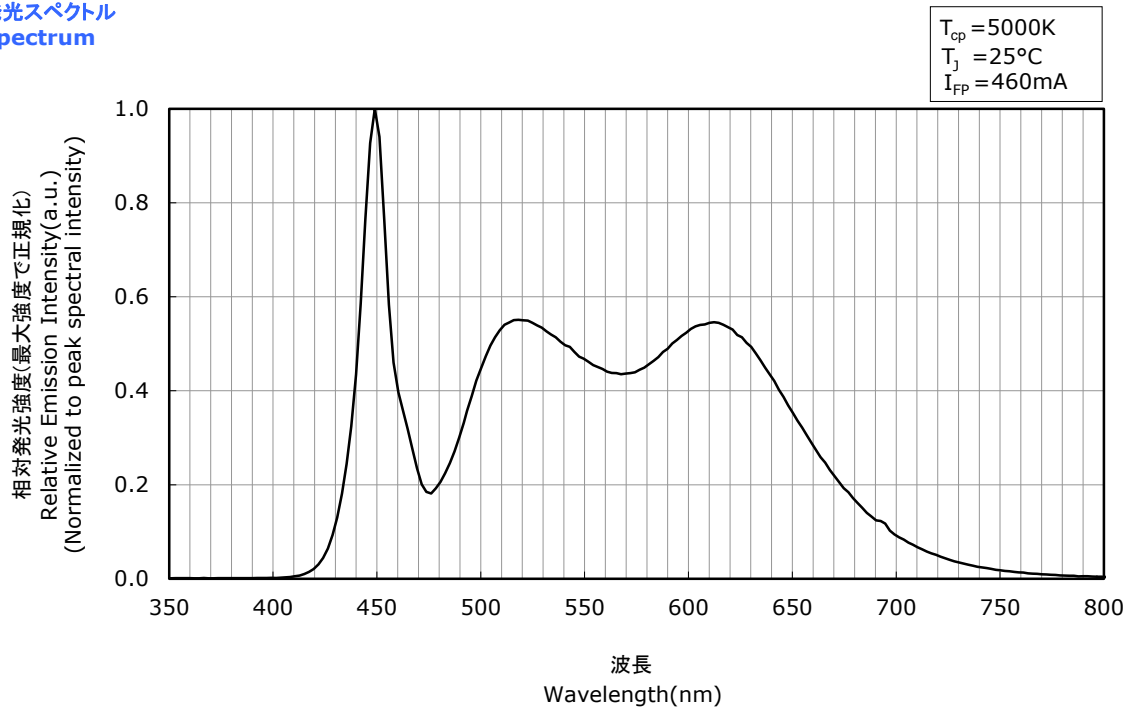

### 指向特性 Directivity

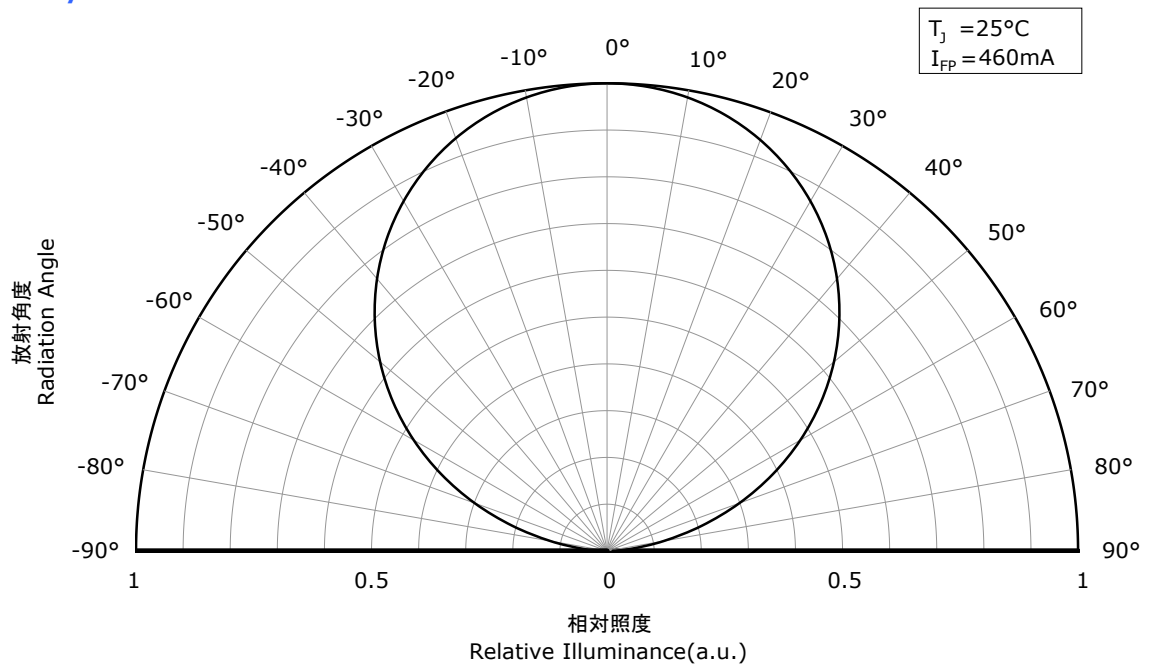

- \* 本特性は演色性ランクR9050に対応しています。  
The graphs above show the characteristics for R9050 LEDs of this product.

# OPTICAL CHARACTERISTICS

- \* 本特性は参考です。  
All characteristics shown are for reference only and are not guaranteed.
- \* パルス駆動により測定しています。  
The following graphs show the characteristics measured in pulse mode.

NFCWL060B-V3  
管理番号 No. STS-DA7-12957

## 発光スペクトル Spectrum

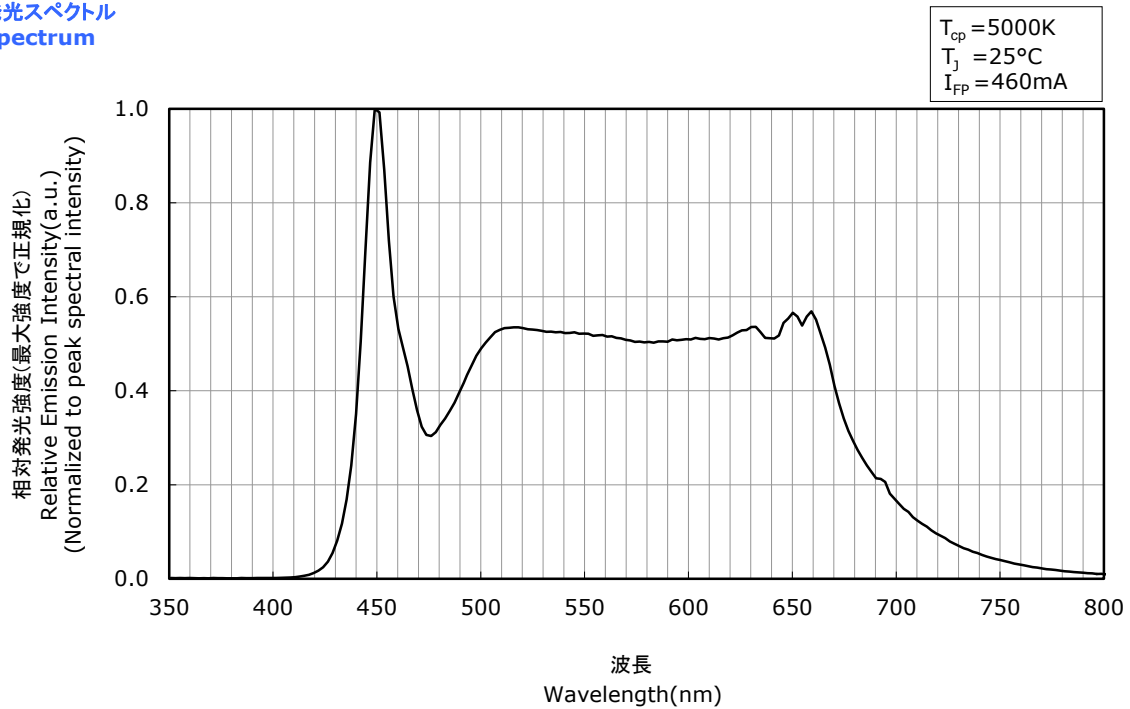

## 指向特性 Directivity

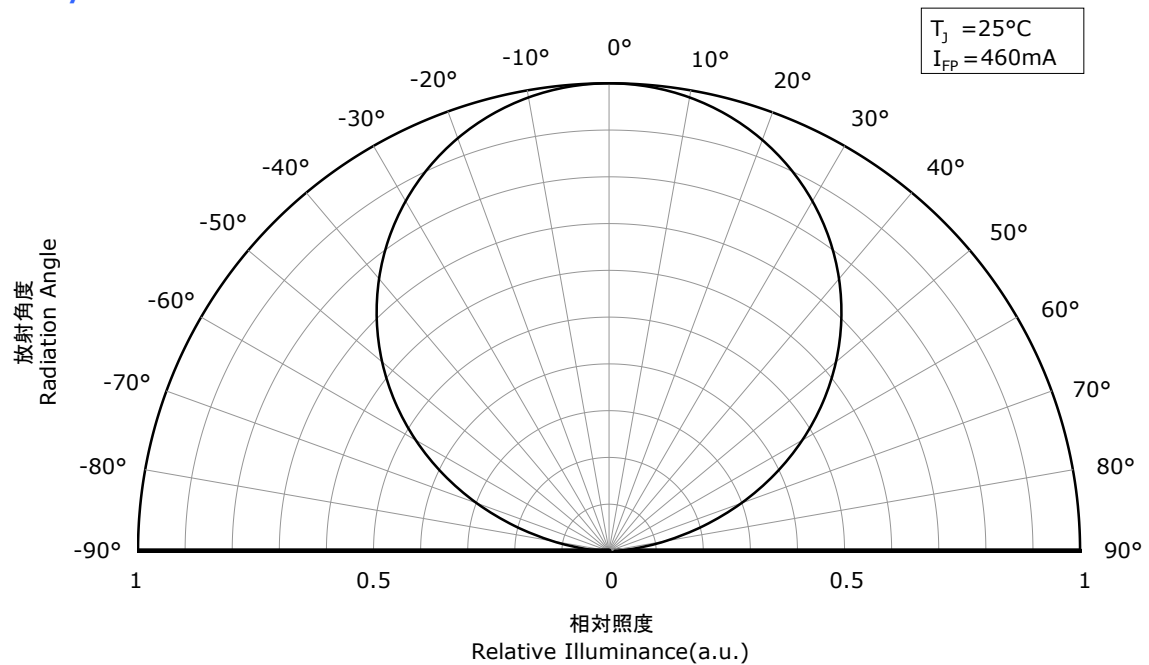

- \* 本特性は演色性ランクR95に対応しています。  
The graphs above show the characteristics for R95 LEDs of this product.

# FORWARD CURRENT CHARACTERISTICS / TEMPERATURE CHARACTERISTICS

- \* 本特性は参考です。  
All characteristics shown are for reference only and are not guaranteed.
- \* パルス駆動により測定しています。  
The following graphs show the characteristics measured in pulse mode.

NFCWL060B-V3  
管理番号 No. STS-DA7-12958

**順電圧-順電流特性**  
**Forward Voltage vs Forward Current**

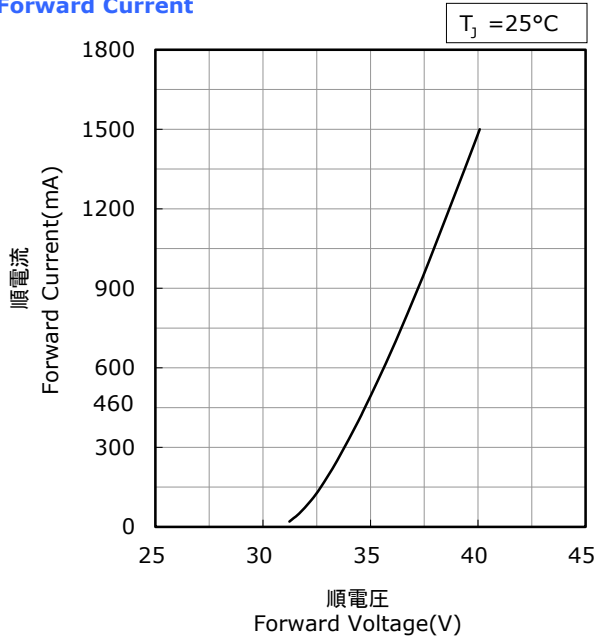

**ジャンクション温度-順電圧特性**  
**Junction Temperature vs Forward Voltage**

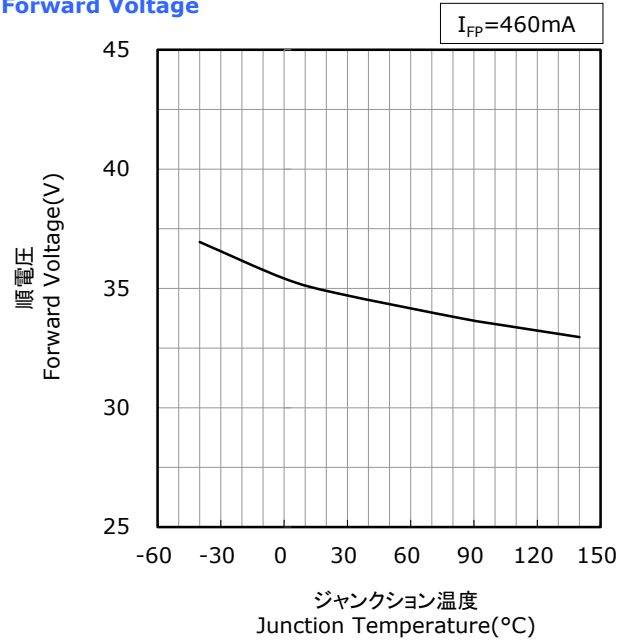

**順電流-相対光束特性**  
**Forward Current vs Relative Luminous Flux**

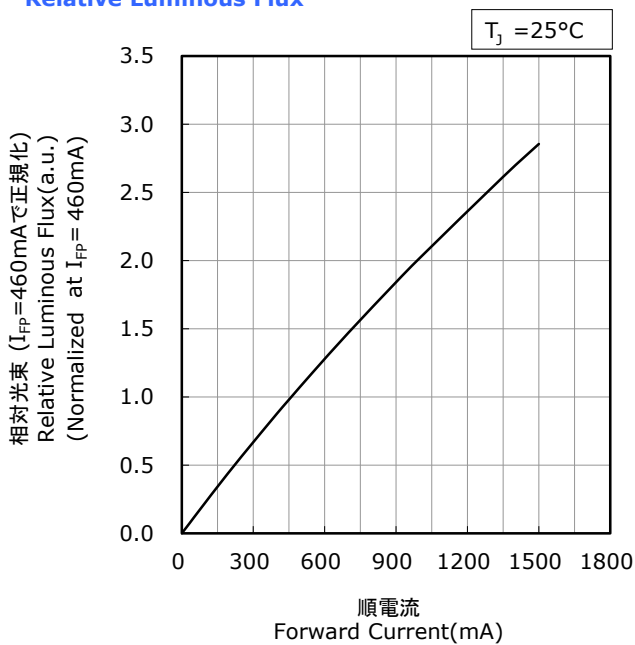

**ジャンクション温度-相対光束特性**  
**Junction Temperature vs Relative Luminous Flux**

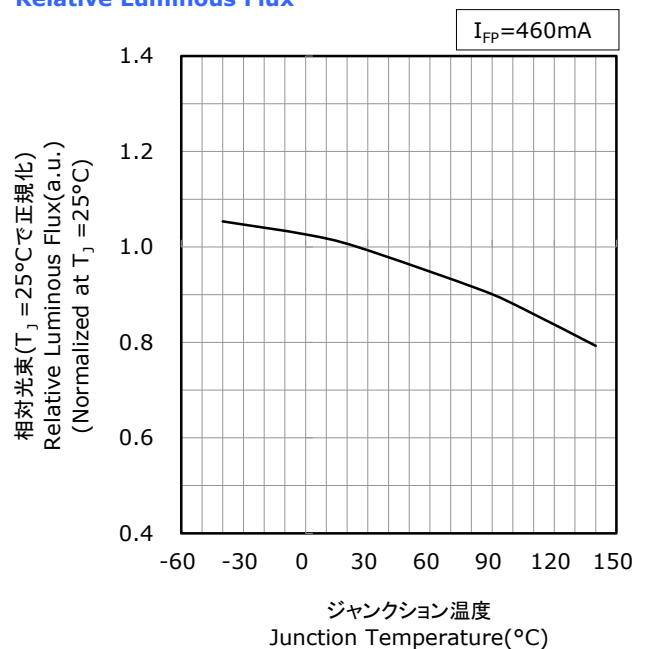

- \* 本特性は色温度2700K~4500K、演色性ランクR70に対応しています。  
The graphs above show the characteristics for 2700K~4500K, R70 LEDs of this product.

# FORWARD CURRENT CHARACTERISTICS / TEMPERATURE CHARACTERISTICS

- \* 本特性は参考です。  
All characteristics shown are for reference only and are not guaranteed.
- \* パルス駆動により測定しています。  
The following graphs show the characteristics measured in pulse mode.

NFCWL060B-V3  
管理番号 No. STS-DA7-12959

順電圧-順電流特性  
Forward Voltage vs  
Forward Current

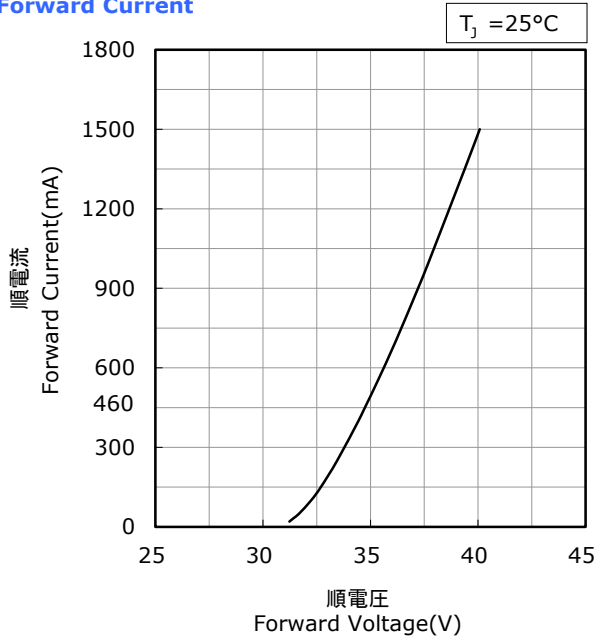

ジャンクション温度-順電圧特性  
Junction Temperature vs  
Forward Voltage

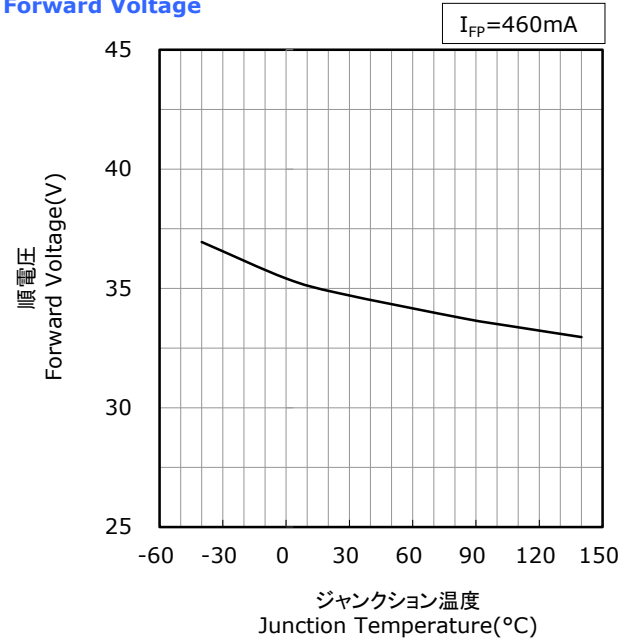

順電流-相対光束特性  
Forward Current vs  
Relative Luminous Flux

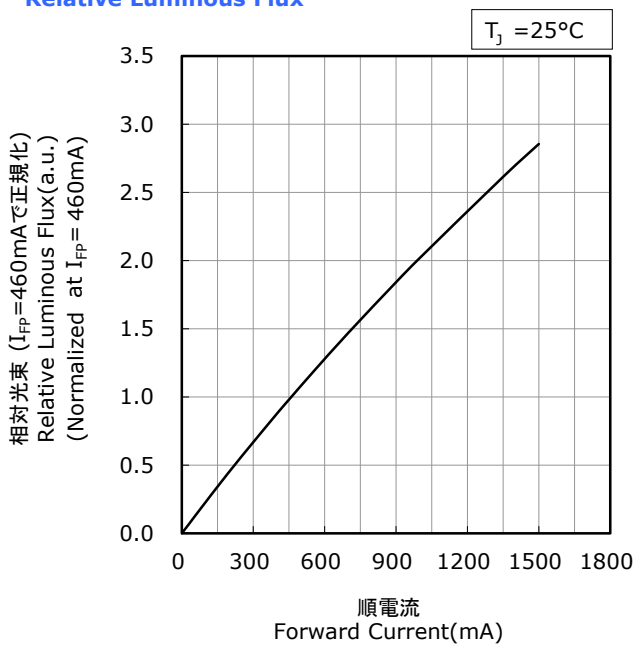

ジャンクション温度-相対光束特性  
Junction Temperature vs  
Relative Luminous Flux

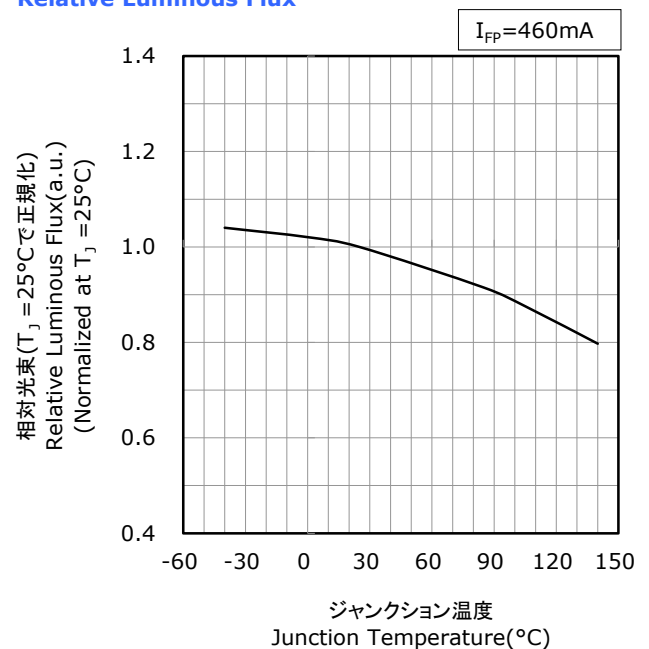

- \* 本特性は色温度2200K~4500K、演色性ランクR8000に対応しています。  
The graphs above show the characteristics for 2200K~4500K, R8000 LEDs of this product.

# FORWARD CURRENT CHARACTERISTICS / TEMPERATURE CHARACTERISTICS

- \* 本特性は参考です。  
All characteristics shown are for reference only and are not guaranteed.
- \* パルス駆動により測定しています。  
The following graphs show the characteristics measured in pulse mode.

NFCWL060B-V3  
管理番号 No. STS-DA7-12960

順電圧-順電流特性  
Forward Voltage vs  
Forward Current

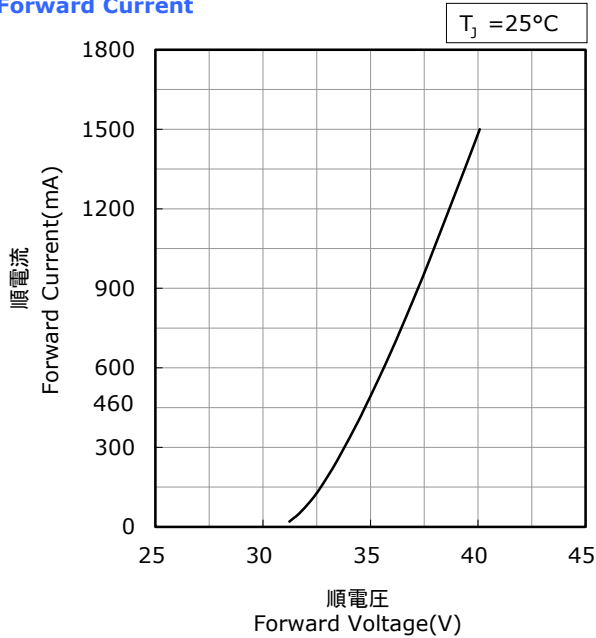

ジャンクション温度-順電圧特性  
Junction Temperature vs  
Forward Voltage

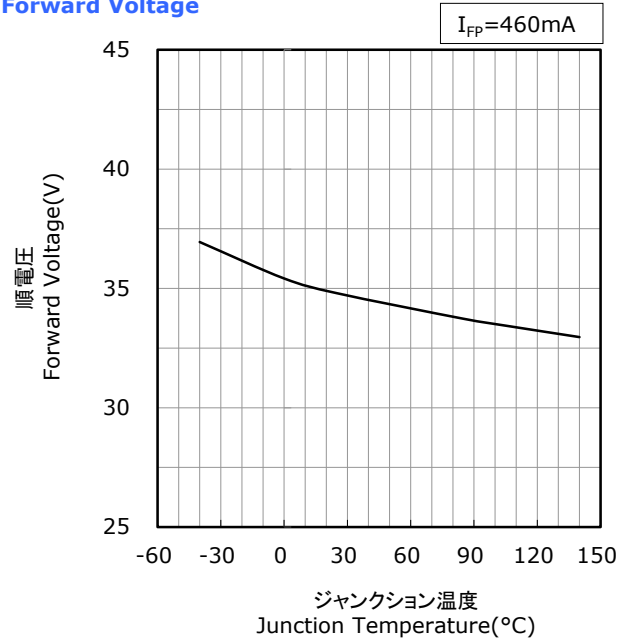

順電流-相対光束特性  
Forward Current vs  
Relative Luminous Flux

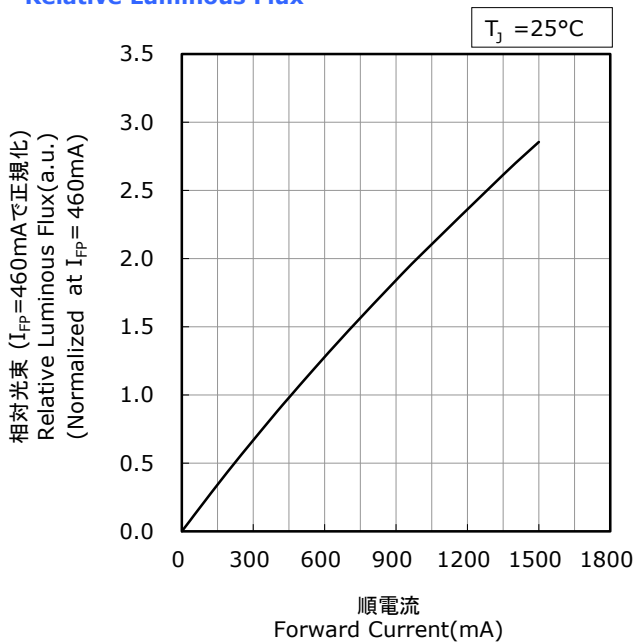

ジャンクション温度-相対光束特性  
Junction Temperature vs  
Relative Luminous Flux

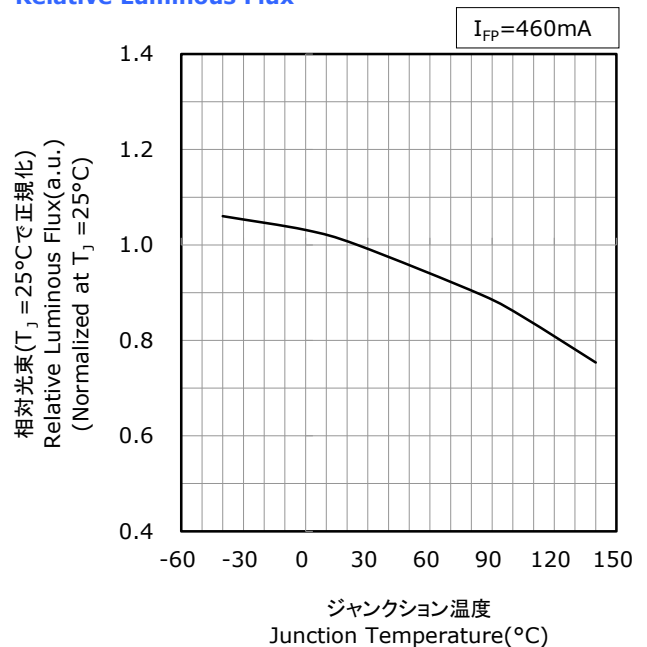

- \* 本特性は色温度2200K~4500K、演色性ランクR9050に対応しています。  
The graphs above show the characteristics for 2200K~4500K, R9050 LEDs of this product.

# FORWARD CURRENT CHARACTERISTICS / TEMPERATURE CHARACTERISTICS

- \* 本特性は参考です。  
All characteristics shown are for reference only and are not guaranteed.
- \* パルス駆動により測定しています。  
The following graphs show the characteristics measured in pulse mode.

NFCWL060B-V3  
管理番号 No. STS-DA7-12961

順電圧-順電流特性  
Forward Voltage vs  
Forward Current

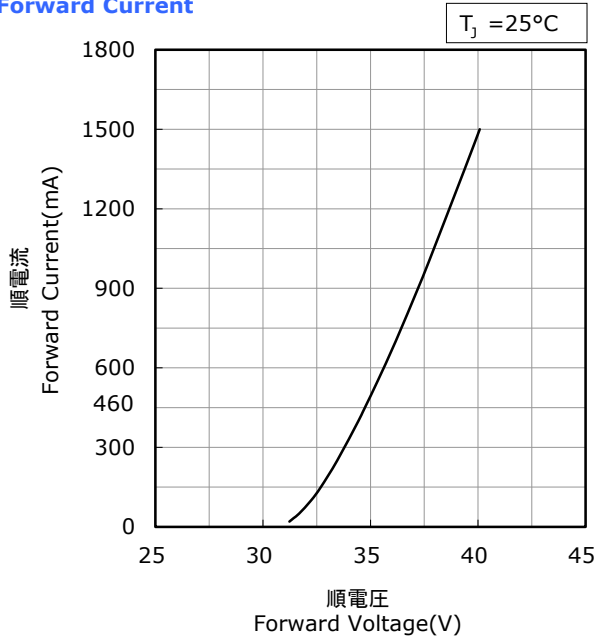

ジャンクション温度-順電圧特性  
Junction Temperature vs  
Forward Voltage

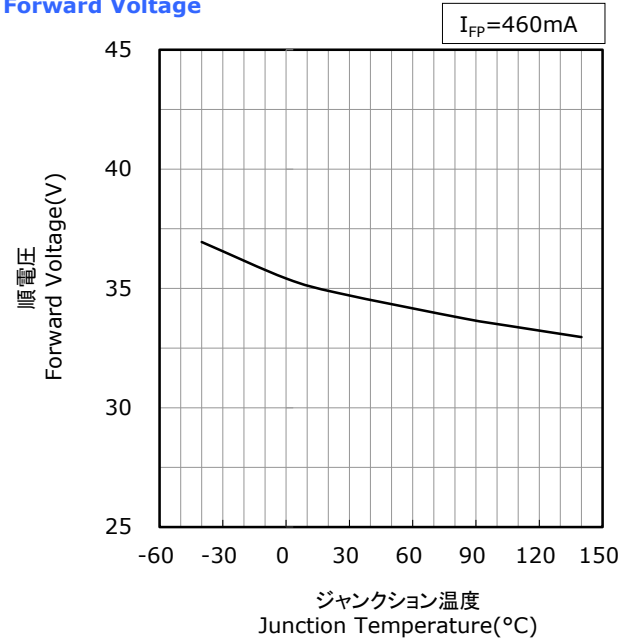

順電流-相対光束特性  
Forward Current vs  
Relative Luminous Flux

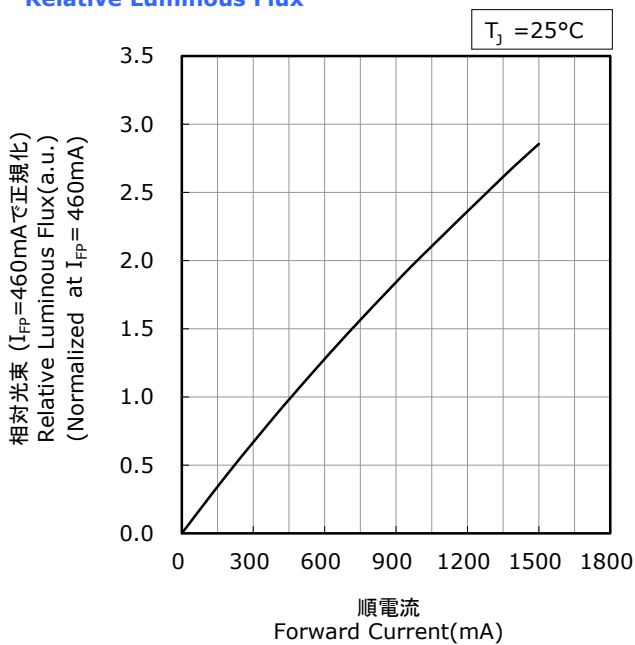

ジャンクション温度-相対光束特性  
Junction Temperature vs  
Relative Luminous Flux

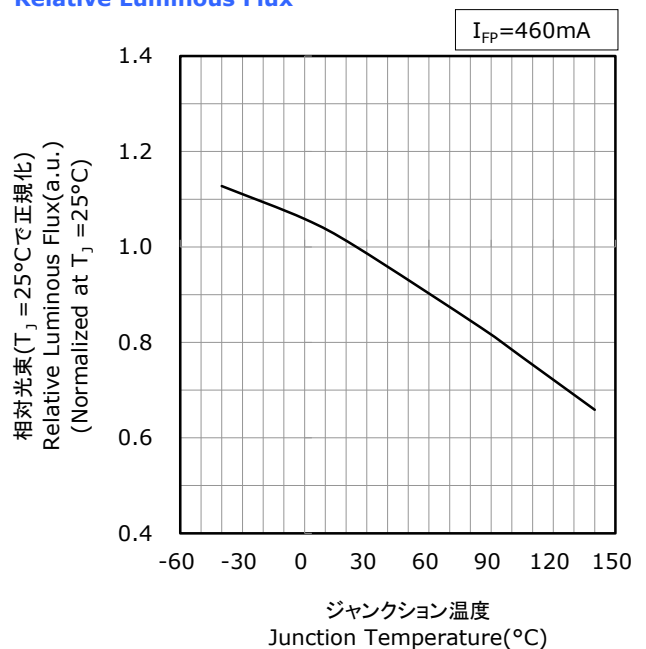

- \* 本特性は色温度2700K~4500K、演色性ランクR95に対応しています。  
The graphs above show the characteristics for 2700K~4500K, R95 LEDs of this product.

# FORWARD CURRENT CHARACTERISTICS / TEMPERATURE CHARACTERISTICS

- \* 本特性は参考です。  
All characteristics shown are for reference only and are not guaranteed.
- \* パルス駆動により測定しています。  
The following graphs show the characteristics measured in pulse mode.

NFCWL060B-V3  
管理番号 No. STS-DA7-12962

順電圧-順電流特性  
Forward Voltage vs  
Forward Current

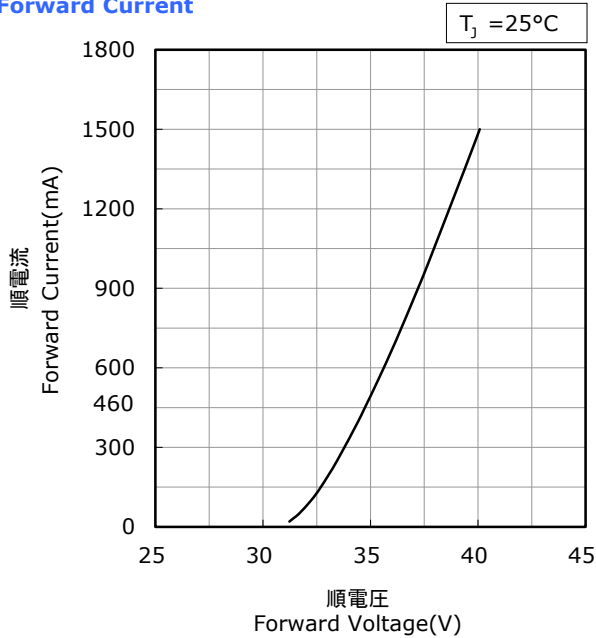

ジャンクション温度-順電圧特性  
Junction Temperature vs  
Forward Voltage

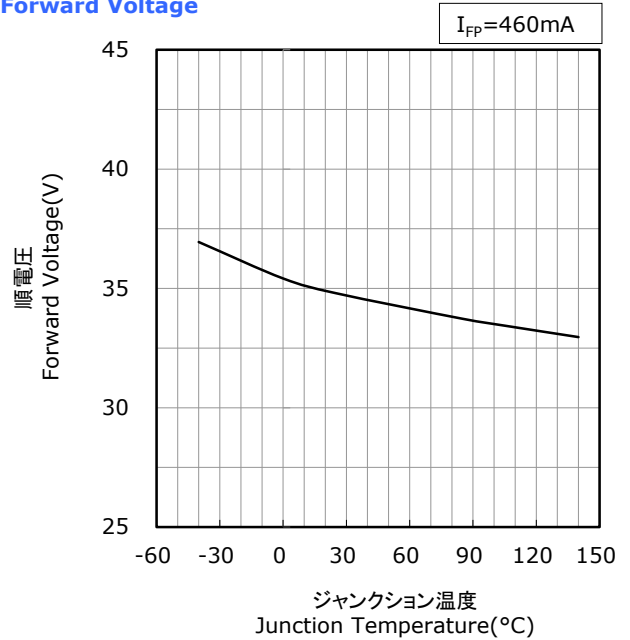

順電流-相対光束特性  
Forward Current vs  
Relative Luminous Flux

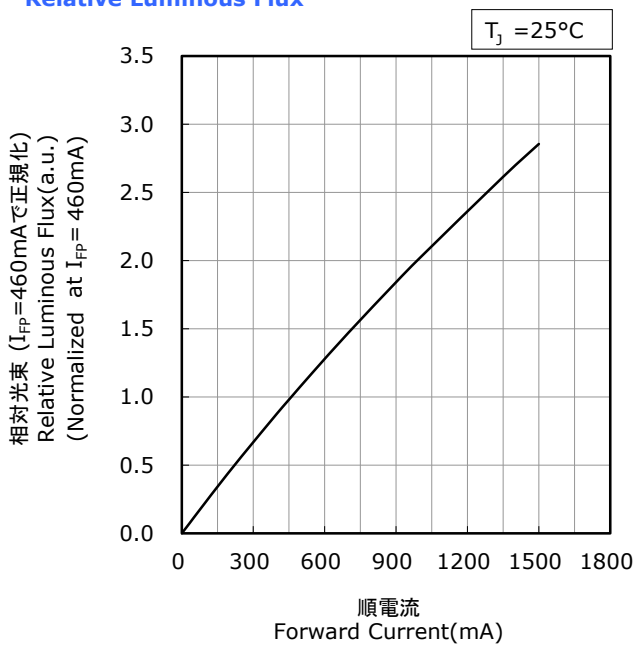

ジャンクション温度-相対光束特性  
Junction Temperature vs  
Relative Luminous Flux

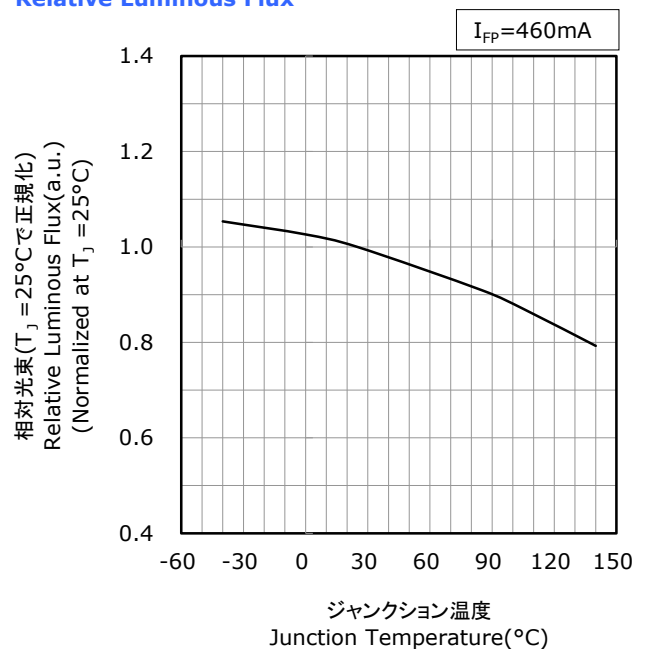

- \* 本特性は色温度5000K~6500K、演色性ランクR70に対応しています。  
The graphs above show the characteristics for 5000K~6500K, R70 LEDs of this product.

# FORWARD CURRENT CHARACTERISTICS / TEMPERATURE CHARACTERISTICS

- \* 本特性は参考です。  
All characteristics shown are for reference only and are not guaranteed.
- \* パルス駆動により測定しています。  
The following graphs show the characteristics measured in pulse mode.

NFCWL060B-V3  
管理番号 No. STS-DA7-12963

順電圧-順電流特性  
Forward Voltage vs  
Forward Current

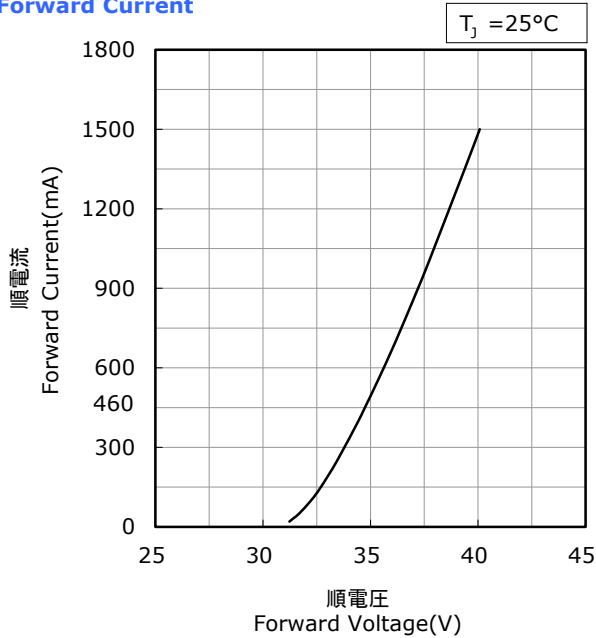

ジャンクション温度-順電圧特性  
Junction Temperature vs  
Forward Voltage

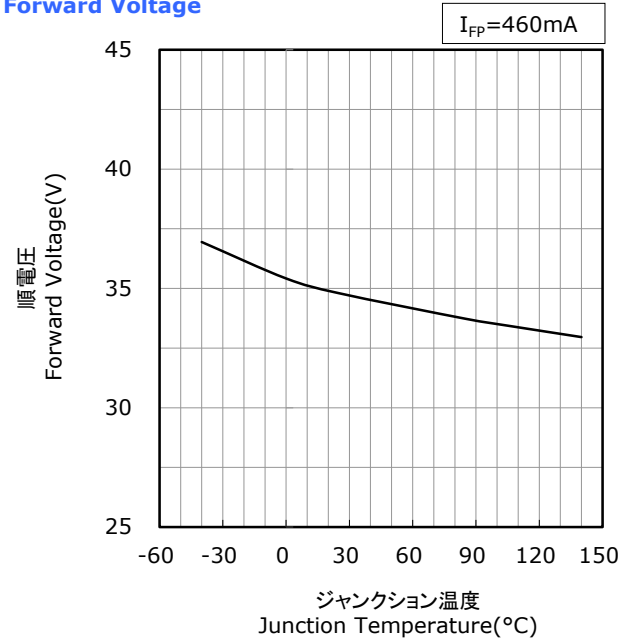

順電流-相対光束特性  
Forward Current vs  
Relative Luminous Flux

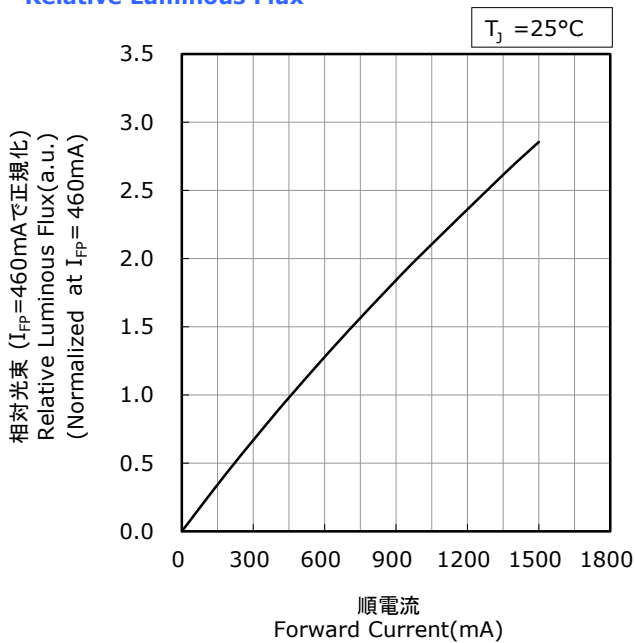

ジャンクション温度-相対光束特性  
Junction Temperature vs  
Relative Luminous Flux

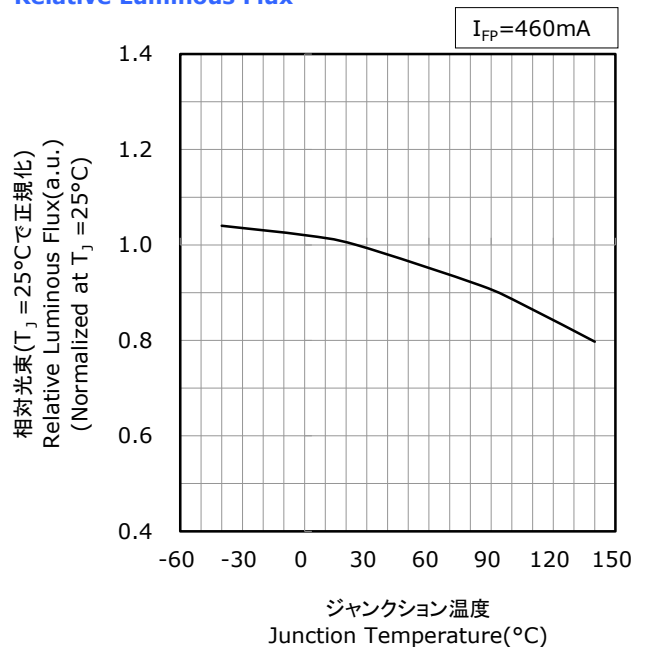

- \* 本特性は色温度5000K~6500K、演色性ランクR8000に対応しています。  
The graphs above show the characteristics for 5000K~6500K, R8000 LEDs of this product.

# FORWARD CURRENT CHARACTERISTICS / TEMPERATURE CHARACTERISTICS

- \* 本特性は参考です。  
All characteristics shown are for reference only and are not guaranteed.
- \* パルス駆動により測定しています。  
The following graphs show the characteristics measured in pulse mode.

NFCWL060B-V3  
管理番号 No. STS-DA7-12964

順電圧-順電流特性  
Forward Voltage vs  
Forward Current

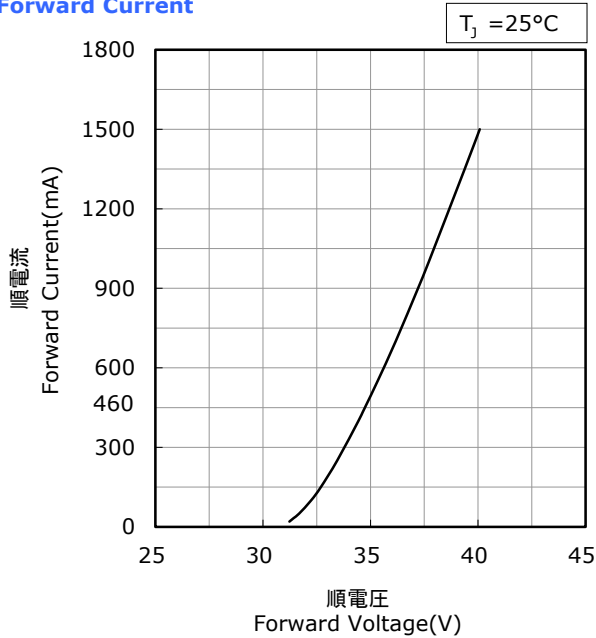

ジャンクション温度-順電圧特性  
Junction Temperature vs  
Forward Voltage

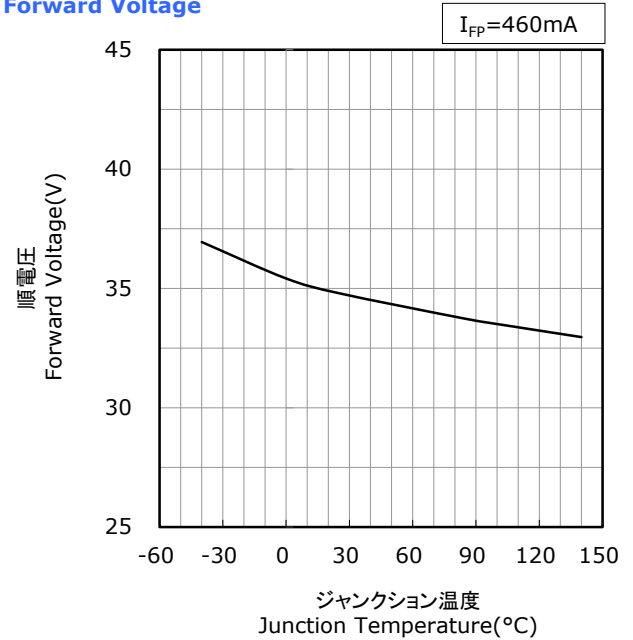

順電流-相対光束特性  
Forward Current vs  
Relative Luminous Flux

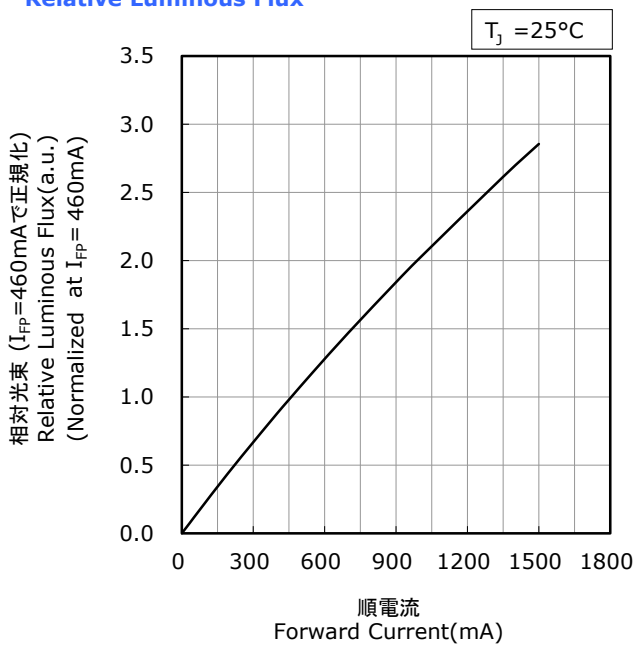

ジャンクション温度-相対光束特性  
Junction Temperature vs  
Relative Luminous Flux

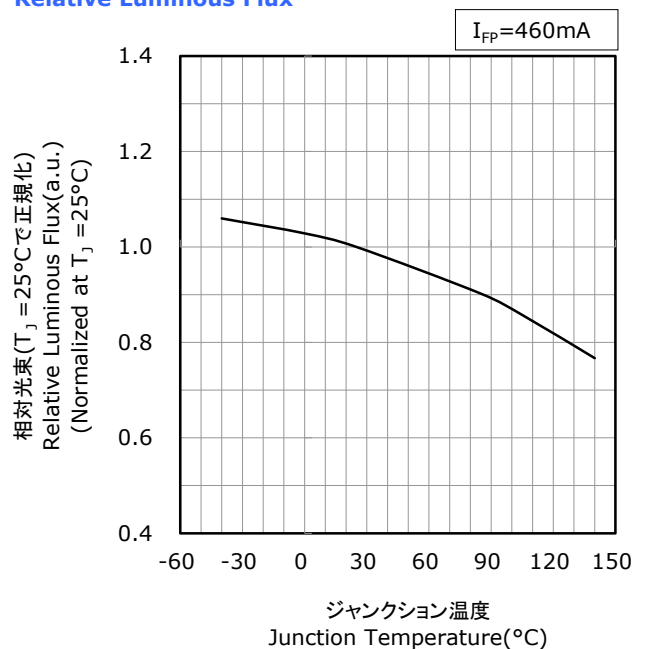

- \* 本特性は色温度5000K~6500K、演色性ランクR9050に対応しています。  
The graphs above show the characteristics for 5000K~6500K, R9050 LEDs of this product.

# FORWARD CURRENT CHARACTERISTICS / TEMPERATURE CHARACTERISTICS

- \* 本特性は参考です。  
All characteristics shown are for reference only and are not guaranteed.
- \* パルス駆動により測定しています。  
The following graphs show the characteristics measured in pulse mode.

NFCWL060B-V3  
管理番号 No. STS-DA7-12965

順電圧-順電流特性  
Forward Voltage vs  
Forward Current

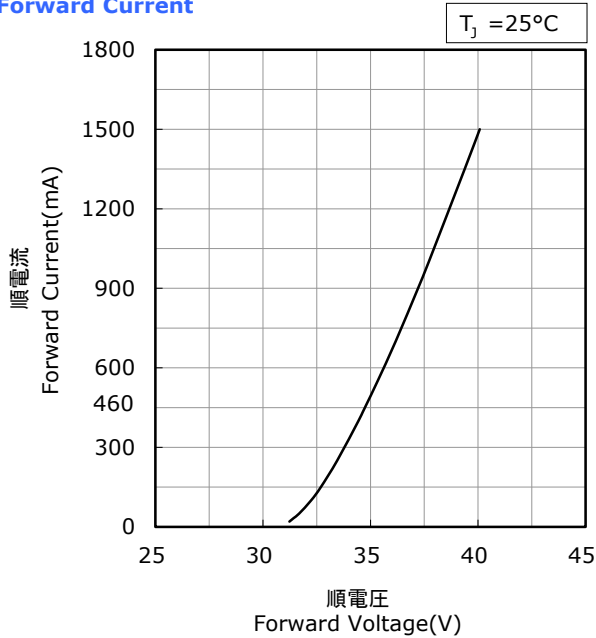

ジャンクション温度-順電圧特性  
Junction Temperature vs  
Forward Voltage

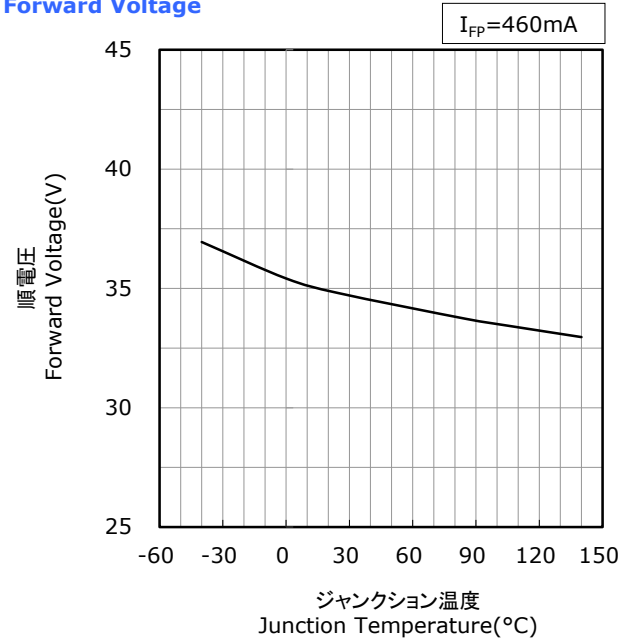

順電流-相対光束特性  
Forward Current vs  
Relative Luminous Flux

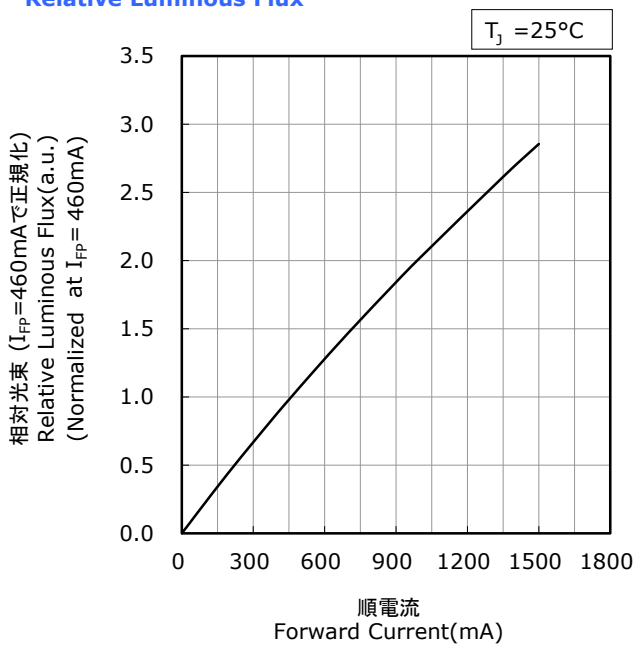

ジャンクション温度-相対光束特性  
Junction Temperature vs  
Relative Luminous Flux

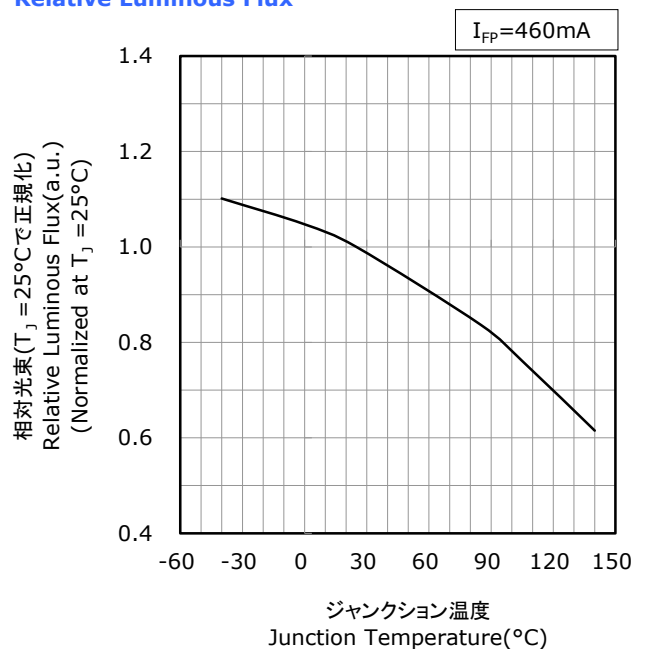

- \* 本特性は色温度5000K~6500K、演色性ランクR95に対応しています。  
The graphs above show the characteristics for 5000K~6500K, R95 LEDs of this product.

## FORWARD CURRENT CHARACTERISTICS / TEMPERATURE CHARACTERISTICS

- \* 本特性は参考です。  
All characteristics shown are for reference only and are not guaranteed.
- \* パルス駆動により測定しています。  
The following graphs show the characteristics measured in pulse mode.

NFCWL060B-V3  
管理番号 No. STS-DA7-12966

順電流-色度 特性  
Forward Current vs  
Chromaticity Coordinate

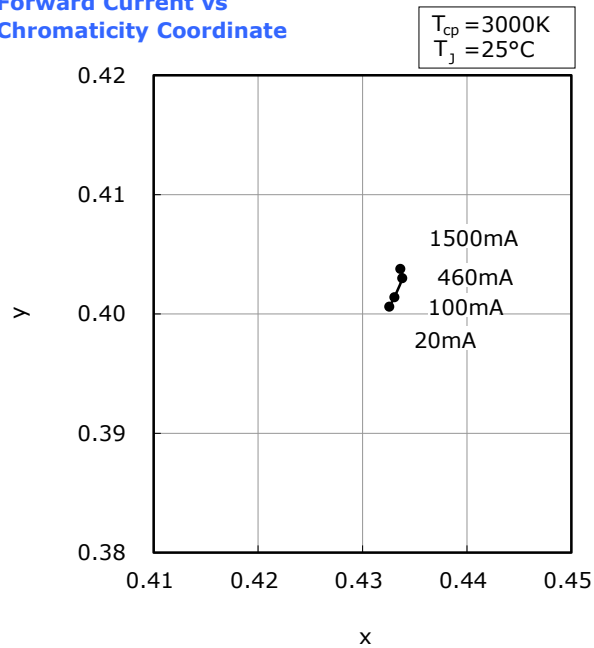

ジャンクション温度-色度 特性  
Junction Temperature vs  
Chromaticity Coordinate

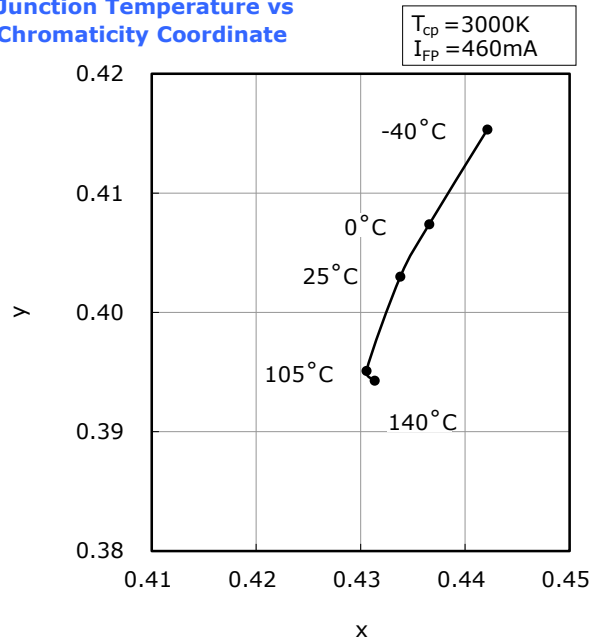

- \* 本特性は演色性ランクR70に対応しています。  
The graphs above show the characteristics for R70 LEDs of this product.

# FORWARD CURRENT CHARACTERISTICS / TEMPERATURE CHARACTERISTICS

- \* 本特性は参考です。  
All characteristics shown are for reference only and are not guaranteed.
- \* パルス駆動により測定しています。  
The following graphs show the characteristics measured in pulse mode.

NFCWL060B-V3  
管理番号 No. STS-DA7-12967

順電流-色度 特性  
Forward Current vs  
Chromaticity Coordinate

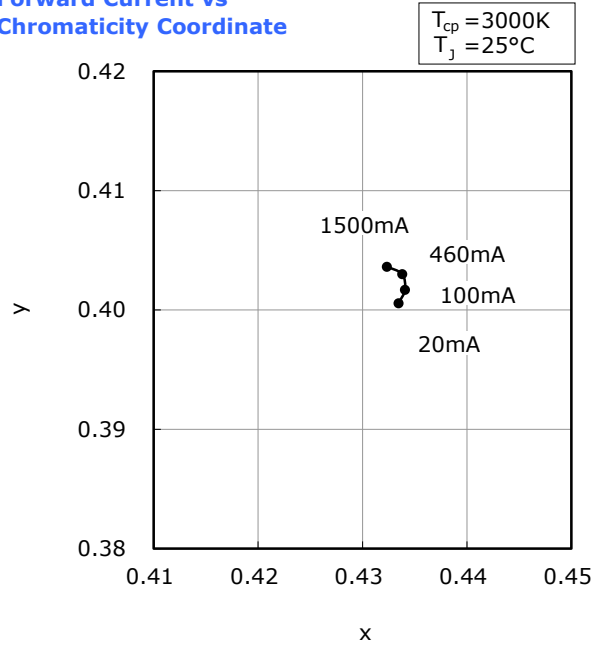

ジャンクション温度-色度 特性  
Junction Temperature vs  
Chromaticity Coordinate

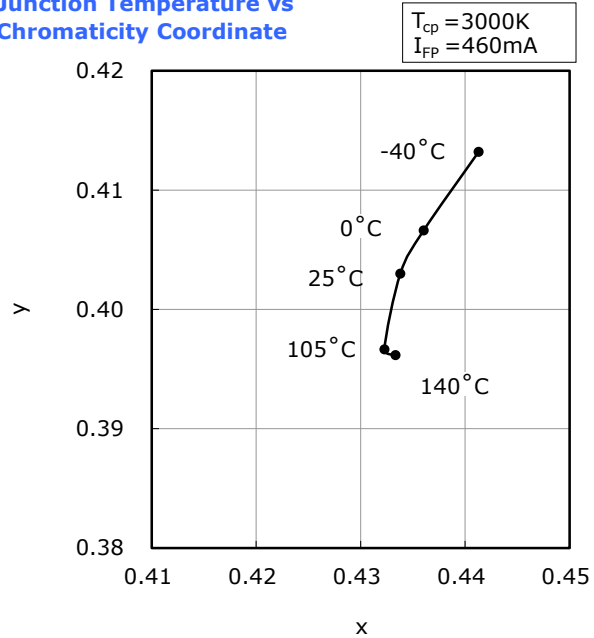

- \* 本特性は演色性ランクR8000に対応しています。  
The graphs above show the characteristics for R8000 LEDs of this product.

## FORWARD CURRENT CHARACTERISTICS / TEMPERATURE CHARACTERISTICS

- \* 本特性は参考です。  
All characteristics shown are for reference only and are not guaranteed.
- \* パルス駆動により測定しています。  
The following graphs show the characteristics measured in pulse mode.

NFCWL060B-V3  
管理番号 No. STS-DA7-12968

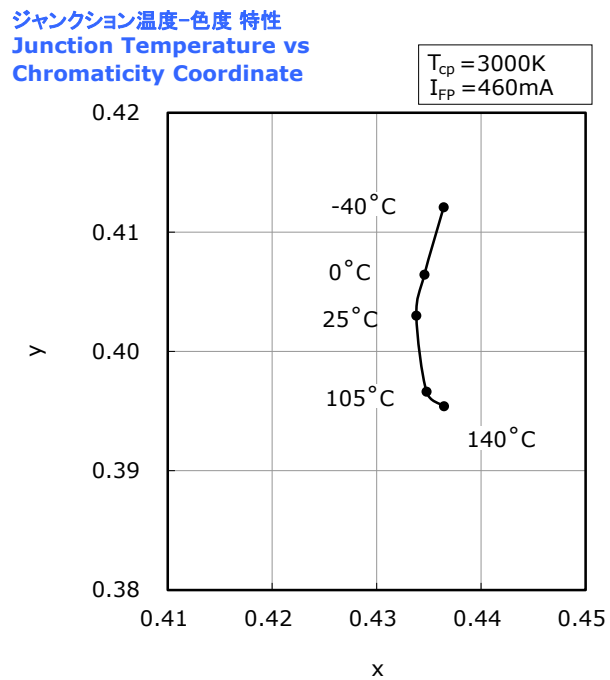
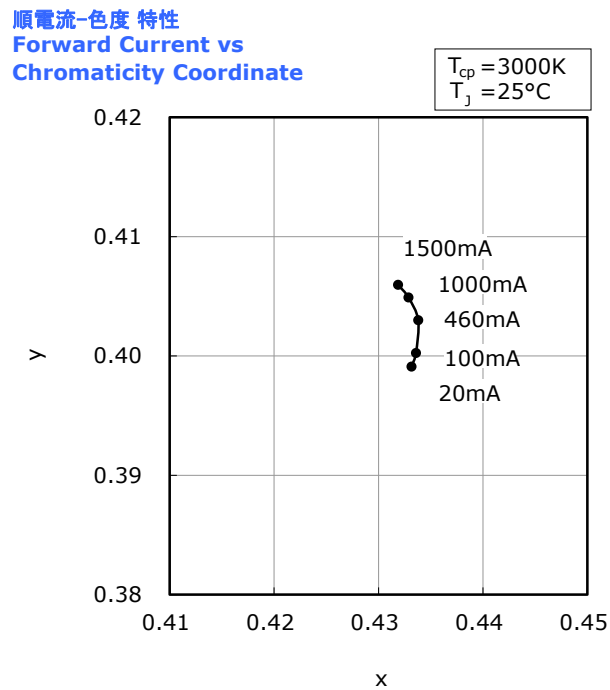

- \* 本特性は演色性ランクR9050に対応しています。  
The graphs above show the characteristics for R9050 LEDs of this product.

## FORWARD CURRENT CHARACTERISTICS / TEMPERATURE CHARACTERISTICS

- \* 本特性は参考です。  
All characteristics shown are for reference only and are not guaranteed.
- \* パルス駆動により測定しています。  
The following graphs show the characteristics measured in pulse mode.

NFCWL060B-V3  
管理番号 No. STS-DA7-12969

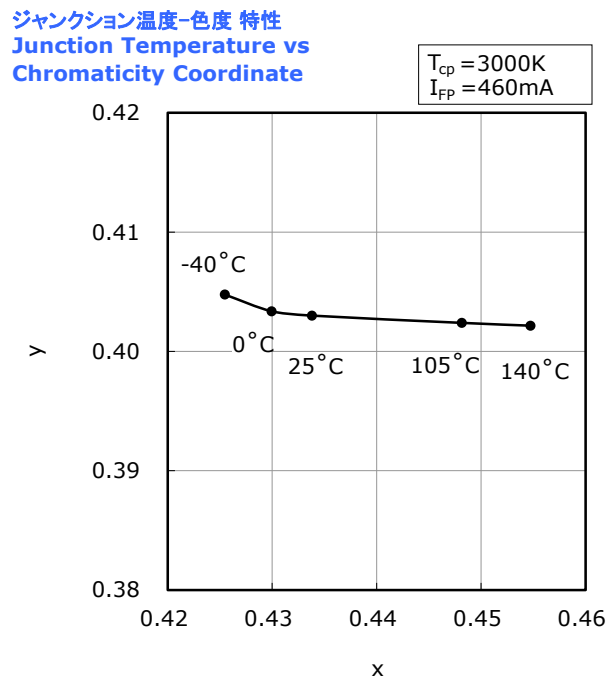
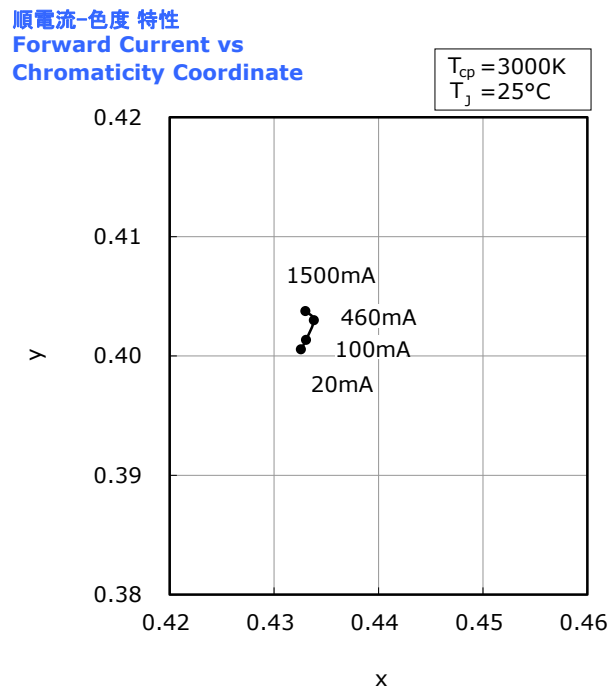

- \* 本特性は演色性ランクR95に対応しています。  
The graphs above show the characteristics for R95 LEDs of this product.

## FORWARD CURRENT CHARACTERISTICS / TEMPERATURE CHARACTERISTICS

- \* 本特性は参考です。  
All characteristics shown are for reference only and are not guaranteed.
- \* パルス駆動により測定しています。  
The following graphs show the characteristics measured in pulse mode.

NFCWL060B-V3  
管理番号 No. STS-DA7-12970

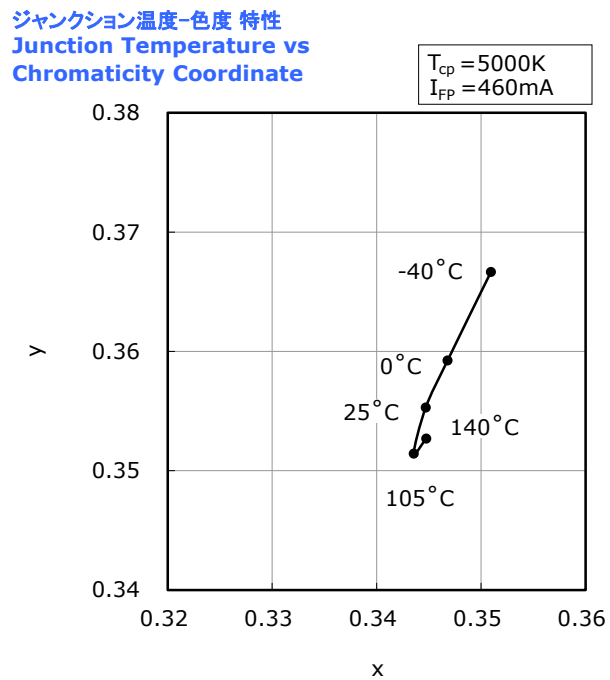
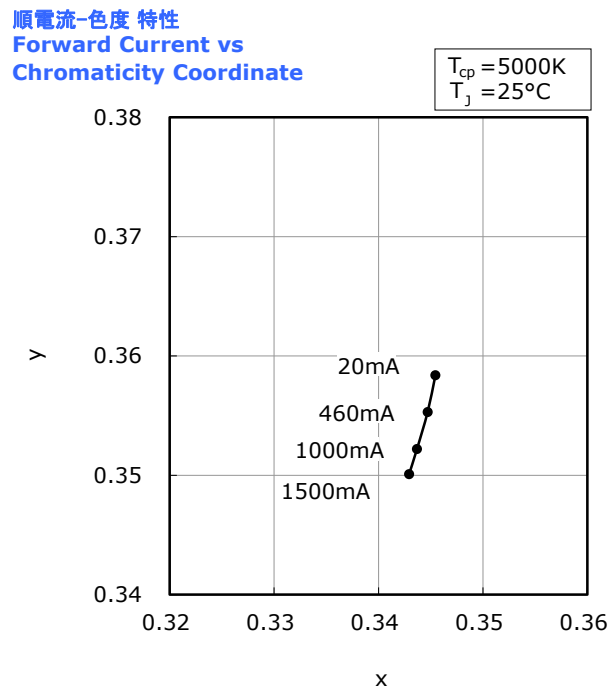

- \* 本特性は演色性ランクR70に対応しています。  
The graphs above show the characteristics for R70 LEDs of this product.

FORWARD CURRENT CHARACTERISTICS / TEMPERATURE CHARACTERISTICS

- \* 本特性は参考です。  
All characteristics shown are for reference only and are not guaranteed.
- \* パルス駆動により測定しています。  
The following graphs show the characteristics measured in pulse mode.

NFCWL060B-V3  
管理番号 No. STS-DA7-12971

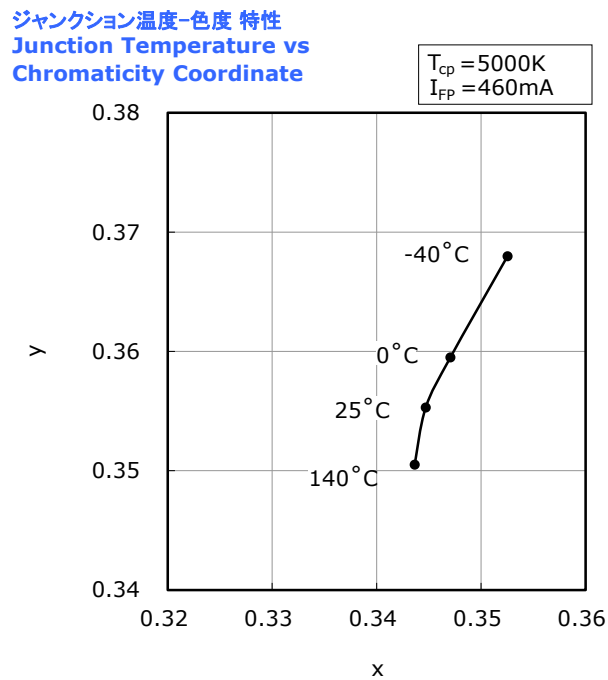
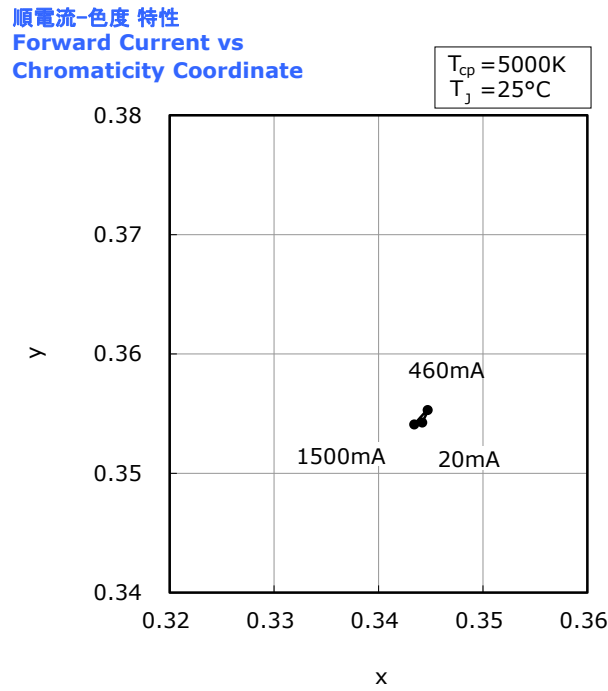

- \* 本特性は演色性ランクR8000に対応しています。  
The graphs above show the characteristics for R8000 LEDs of this product.

## FORWARD CURRENT CHARACTERISTICS / TEMPERATURE CHARACTERISTICS

- \* 本特性は参考です。  
All characteristics shown are for reference only and are not guaranteed.
- \* パルス駆動により測定しています。  
The following graphs show the characteristics measured in pulse mode.

NFCWL060B-V3  
管理番号 No. STS-DA7-12972

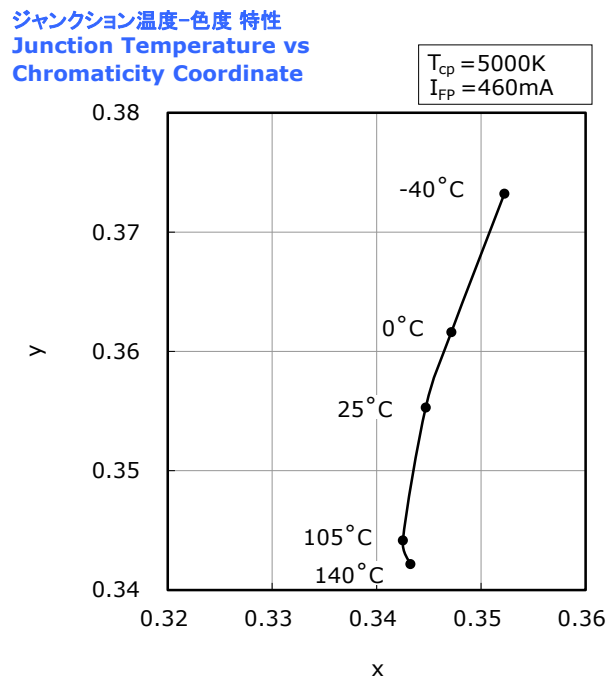
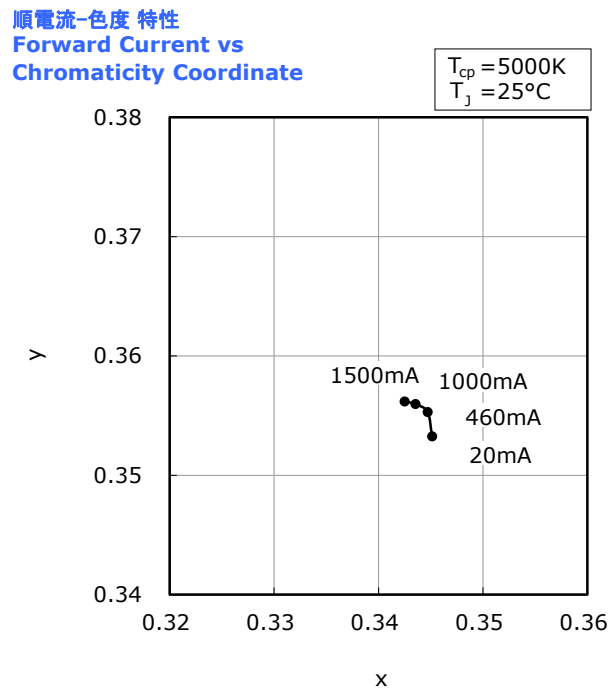

- \* 本特性は演色性ランクR9050に対応しています。  
The graphs above show the characteristics for R9050 LEDs of this product.

## FORWARD CURRENT CHARACTERISTICS / TEMPERATURE CHARACTERISTICS

- \* 本特性は参考です。  
All characteristics shown are for reference only and are not guaranteed.
- \* パルス駆動により測定しています。  
The following graphs show the characteristics measured in pulse mode.

NFCWL060B-V3  
管理番号 No. STS-DA7-12973

順電流-色度 特性  
Forward Current vs  
Chromaticity Coordinate

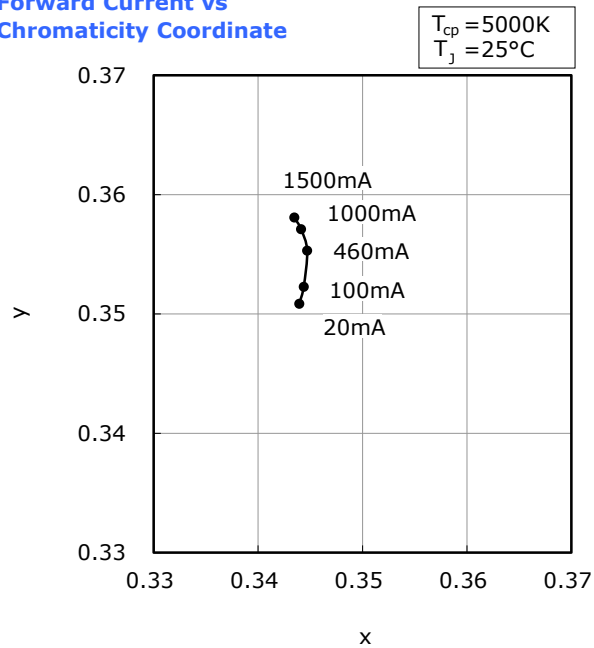

ジャンクション温度-色度 特性  
Junction Temperature vs  
Chromaticity Coordinate

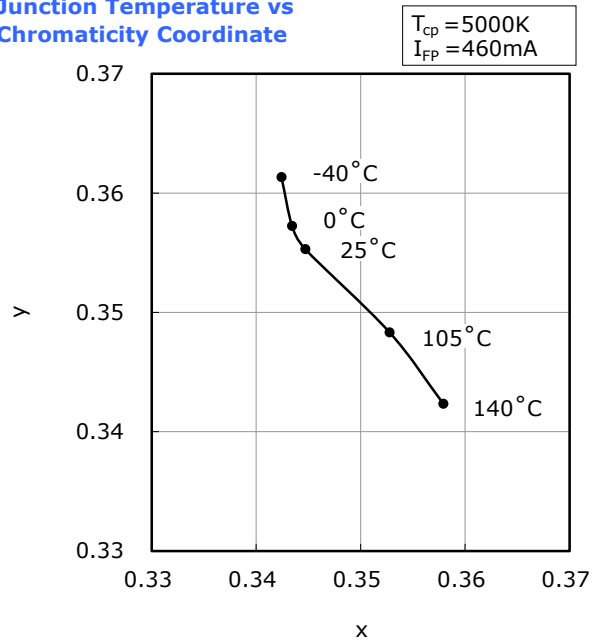

- \* 本特性は演色性ランクR95に対応しています。  
The graphs above show the characteristics for R95 LEDs of this product.

## RELIABILITY

### (1) Tests and Results

Test	Reference Standard	Test Conditions	Test Duration	Failure Criteria #	Units Failed/Tested
Thermal Shock		-40°C to 100°C, 15min dwell	100cycles	#1	0/10
High Temperature Storage	JEITA ED-4701 200 201	T <sub>A</sub> =100°C	1000hours	#1	0/10
Temperature Humidity Storage	JEITA ED-4701 100 103	T <sub>A</sub> =60°C, RH=90%	1000hours	#1	0/10
Low Temperature Storage	JEITA ED-4701 200 202	T <sub>A</sub> =-40°C	1000hours	#1	0/10
High Temperature Operating Life		T <sub>C</sub> =79°C, I <sub>F</sub> =1000mA	1000hours	#1	0/10
Electrostatic Discharges	JEITA ED-4701 300 304	HBM, 2kV, 1.5kΩ, 100pF, 3pulses, alternately positive or negative		#1	0/10

NOTES:

Measurements are performed after allowing the LEDs to return to room temperature.

### (2) Failure Criteria

Criteria #	Items	Conditions	Failure Criteria
#1	Forward Voltage(V <sub>F</sub> )	I <sub>F</sub> =460mA	>Initial value×1.1
	Luminous Flux(Φ <sub>V</sub> )	I <sub>F</sub> =460mA	<Initial value×0.7

## CAUTIONS

### (1) Storage

Conditions		Temperature	Humidity	Time
Storage	Before Opening Aluminum Bag	≤30°C	≤90%RH	Within 1 Year from Delivery Date
	After Opening Aluminum Bag	≤30°C	≤70%RH	≤168hours

- Once the moisture-proof aluminum bag is open, ensure that the LED is soldered to a PCB within the range of the conditions above. To store any remaining unused LEDs, use a hermetically sealed container with silica gel desiccants. Nichia recommends placing them back to the original moisture-proof bag and reseal it.
- This LED has gold-plated electrodes. If the LEDs are exposed to a corrosive environment, it may cause the plated surface to tarnish causing issues. Ensure that when storing LEDs, a hermetically sealed container is used. Nichia recommends placing them back to the original moisture-proof bag and reseal it.
- To prevent substances/gases from affecting the plated surface, ensure that the parts/materials used with the LEDs in the same assembly/system do not contain sulfur (e.g. gasket/seal, adhesive, etc.). If the plating is contaminated, it may cause issues (e.g. electric connection failures). If a gasket/seal is used, silicone rubber gaskets/seals are recommended; ensure that this use of silicone does not result in issues (e.g. electrical connection failures) caused by low molecular weight volatile siloxane.
- To avoid condensation, the LEDs must not be stored in areas where temperature and humidity fluctuate greatly.
- Do not store the LEDs in a dusty environment.
- Do not expose the LEDs to direct sunlight and/or an environment over a long period of time where the temperature is higher than normal room temperature.

### (2) Directions for Use

- The circuit must be designed to ensure that the Absolute Maximum Ratings are not exceeded for each LED. The LEDs should be operated at a constant current per LED. In the case of operating at a constant voltage, Circuit B is recommended. If Circuit A is used, it may cause the currents flowing through the LEDs to vary due to the variation in the forward voltage characteristics of the LEDs on the circuit.

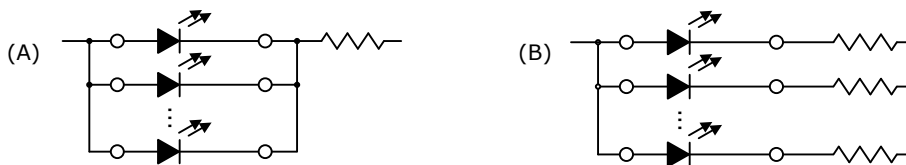

- This LED is designed to be operated at a forward current. Ensure that no voltage is applied to the LED in the forward/reverse direction while the LED is off. If the LEDs are used in an environment where reverse voltages are applied to the LED continuously, it may cause electrochemical migration to occur causing the LED to be damaged. When not in use for a long period of time, the system's power should be turned off to ensure that there are no issues/damage.
- When using the LEDs with a dimmer, the color may vary depending on the current through the LED; it is recommended to operate the LED with pulse width modulation (PWM) to minimize this issue.
- To stabilize the LED characteristics while in use, Nichia recommends that the LEDs are operated at currents  $\geq 10\%$  of the sorting current.
- Ensure that transient excessive voltages (e.g. lighting surge) are not applied to the LEDs.
- If the LEDs are used for outdoor applications, ensure that necessary measures are taken (e.g. protecting the LEDs from water/salt damage and high humidity).

### (3) Handling Precautions

- Do not handle the LEDs with bare hands:
  - this may contaminate the LED surface and have an effect on the optical characteristics,
  - this may cause the LED to deform and/or the wire to break causing a catastrophic failure (i.e. the LED not to illuminate).
- Ensure that when handling the LEDs with tweezers, excessive force is not applied to the LED. Otherwise, it may cause damage to the resin (e.g. cut, scratch, chip, crack, delamination and deformation) and the wire to break causing a catastrophic failure (i.e. the LED not to illuminate).
- Dropping may cause damage to the LED (e.g. deformation).
- Do not stack the LEDs. Otherwise, it may cause damage to the resin (e.g. cut, scratch, chip, crack, delamination and deformation) and the wire to break causing a catastrophic failure (i.e. the LED not to illuminate).

#### (4) Design Consideration

- Volatile organic compounds that have been released from materials present around the LEDs (e.g. housing, gasket/seal, adhesive, secondary lens, lens cover, etc.) may penetrate the LED lens and/or encapsulating resin. If the LEDs are being used in a hermetically sealed environment, these volatile compounds can discolor after being exposed to heat and/or photon energy and it may greatly reduce the LED light output and/or color shift. In this case, ventilating the environment may improve the reduction in light output and/or color shift. Perform a light-up test of the chosen application for optical evaluation to ensure that there are no issues, especially if the LEDs are planned to be used in a hermetically sealed environment.
- This LED uses a ceramic material for the substrate; if the LED is attached to a housing in an inappropriate manner (e.g. uneven application of force to the ceramic substrate, unstable holding, etc.), it may cause the substrate to crack. Nichia recommends using a specially designed holder to attach the LEDs to a housing.
- If the LEDs are attached to a housing without a thermal interface material (e.g. thermal film, thermal grease, etc.), it may cause the heat dissipation to decrease. Nichia recommends using a thermal interface material between the LED and housing.

#### (5) Electrostatic Discharge (ESD)

- This LED is sensitive to transient excessive voltages (e.g. ESD, lightning surge). If this excessive voltage occurs in the circuit, it may cause the LED to be damaged causing issues (e.g. the LED to become dimmer or not to illuminate [i.e. catastrophic failure]). Ensure that when handling the LEDs, necessary measures are taken to protect them from an ESD discharge. The following examples are recommended measures to eliminate the charge:
  - Grounded wrist strap, ESD footwear, clothes, and floors
  - Grounded workstation equipment and tools
  - ESD table/shelf mat made of conductive materials
- Ensure that all necessary measures are taken to prevent the LEDs from being exposed to transient excessive voltages (e.g. ESD, lightning surge):
  - tools (e.g. soldering irons), jigs, and machines that are used are properly grounded
  - appropriate ESD materials/equipment are used in the work area
  - the system/assembly is designed to provide ESD protection for the LEDs.
- If the tool/equipment used is an insulator (e.g. glass cover, plastic, etc.), ensure that necessary measures have been taken to protect the LED from transient excessive voltages (e.g. ESD). The following examples are recommended measures to eliminate the charge:
  - Dissipating static charge with conductive materials
  - Preventing charge generation with moisture
  - Neutralizing the charge with ionizers

## (6) Thermal Management

- When using this product, ensure that proper thermal management is provided and the die temperature does not exceed the maximum Junction Temperature ( $T_J$ ). The temperature at the LED junction, once the saturation temperature has been reached, can be calculated using the following equation:

$$T_J = T_C + R_{\theta JC} \cdot W$$

\* $T_J$  = LED Junction Temperature: °C

$T_C$  = Case Temperature: °C

$R_{\theta JC}$  = Thermal Resistance from Junction to  $T_C$  Measurement Point: °C/W

$W$  = Input Power ( $I_F \times V_F$ ): W

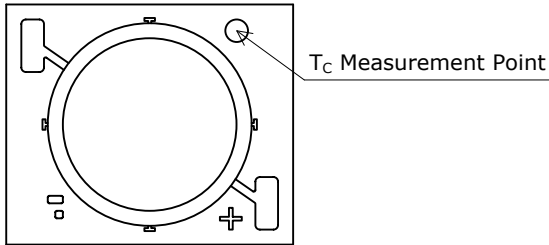

- $R_{\theta JC}$  may change depending on the properties for both the thermal interface material used (e.g. film, gel sheet, paste, or glue) and the heat sink/housing and the surface state of those materials. Ensure that when mounting the LEDs on to the heat sink/housing, the following points are considered:

- A thermal interface material with a low thermal resistance should be used for the interface between the LED and heat sink/housing.
- The surface of the heat sink used with the LEDs must not have any small recesses, cavities, or holes; if necessary, the surface must be leveled before mounting the LEDs.
- If a holder and/or thermal interface material are used, ensure that these materials are properly used and the heat is effectively dissipated.

During use if the thermal interface material deteriorates due to heat and the dimensions change and/or the properties degrade, it may cause these materials not to dissipate the heat properly; this may cause the LED to be damaged. Ensure that reliability verification is performed for the chosen application.

- When measuring the temperatures of LEDs for the thermal management design, a non-contact temperature measuring instrument (e.g. thermal imaging camera) should be used.
- Refer to the relevant application notes for detailed information (e.g. how to handle the COB LEDs, the effect of adhesion strength between the COB and the housing, thermal design considerations, etc.). To access the application notes, go to the Technical Suggestions And Recommendations section of Nichia's website.**

## (7) Cleaning

- Do not clean the LEDs with water, benzine and/or thinner.
- To clean the LEDs, use isopropyl alcohol (IPA). If another solvent is used, it may cause the LED package/resin to be damaged causing issues; ensure that sufficient verification is performed prior to use. Additionally, ensure that the solvent being used does not cause any other issues (e.g. CFC-based solvents are heavily regulated).
- If an LED is contaminated (e.g. dust/dirt), use a cloth soaked with isopropyl alcohol (IPA). Ensure that the cloth is firmly squeezed before wiping the LED.
- Do not clean the LEDs with an ultrasonic cleaner. If cleaning must be done, ensure that sufficient verification is performed by using a finished assembly with LEDs to determine cleaning conditions (e.g. ultrasonic power, LED position on the PCB assembly) that do not cause an issue.

## (8) Eye Safety

- There may be two important international specifications that should be noted for safe use of the LEDs: IEC 62471:2006 Photobiological safety of lamps and lamp systems and IEC 60825-1:2001 (i.e. Edition 1.2) Safety of Laser Products - Part 1: Equipment Classification and Requirements. Ensure that when using the LEDs, there are no issues with the following points:
  - LEDs have been removed from the scope of IEC 60825-1 since IEC 60825-1:2007 (i.e. Edition 2.0) was published. However, depending on the country/region, there are cases where the requirements of the IEC 60825-1:2001 specifications or equivalent must be adhered to.
  - LEDs have been included in the scope of IEC 62471:2006 since the release of the specification in 2006.
  - Most Nichia LEDs will be classified as the Exempt Group or Risk Group 1 according to IEC 62471:2006. However, in the case of high-power LEDs containing blue wavelengths in the emission spectrum, there are LEDs that will be classified as Risk Group 2 depending on the characteristics (e.g. radiation flux, emission spectrum, directivity, etc.)
  - If the LED is used in a manner that produces an increased output or with an optic to collimate the light from the LED, it may cause damage to the human eye.
- If an LED is operated in a manner that emits a flashing light, it may cause health issues (e.g. visual stimuli causing eye discomfort). The system should be designed to ensure that there are no harmful effects on the human body.

## (9) Miscellaneous

- Nichia warrants that the discrete LEDs will meet the requirements/criteria as detailed in the Reliability section within this specification. If the LEDs are used under conditions/environments deviating from or inconsistent with those described in this specification, the resulting damage and/or injuries will not be covered by this warranty.
- Nichia warrants that the discrete LEDs manufactured and/or supplied by Nichia will meet the requirements/criteria as detailed in the Reliability section within this specification; it is the customer's responsibility to perform sufficient verification prior to use to ensure that the lifetime and other quality characteristics required for the intended use are met.
- The applicable warranty period is one year from the date that the LED is delivered. In the case of any incident that appears to be in breach of this warranty, the local Nichia sales representative should be notified to discuss instructions on how to proceed while ensuring that the LED in question is not disassembled or removed from the PCB if it has been attached to the PCB. If a breach of this warranty is proved, Nichia will provide the replacement for the non-conforming LED or an equivalent item at Nichia's discretion. FOREGOING ARE THE EXCLUSIVE REMEDIES AVAILABLE TO THE CUSTOMER IN RESPECT OF THE BREACH OF THE WARRANTY CONTAINED HEREIN, AND IN NO EVENT SHALL NICHIA BE RESPONSIBLE FOR ANY INDIRECT, INCIDENTAL OR CONSEQUENTIAL LOSSES AND/OR EXPENSES (INCLUDING LOSS OF PROFIT) THAT MAY BE SUFFERED BY THE CUSTOMER ARISING OUT OF A BREACH OF THE WARRANTY.
- NICHIA DISCLAIMS ALL OTHER WARRANTIES, EXPRESS OR IMPLIED, INCLUDING THE IMPLIED WARRANTIES OF MERCHANTABILITY AND FITNESS FOR A PARTICULAR PURPOSE.
- This LED is intended to be used for general lighting, household appliances, electronic devices (e.g. mobile communication devices); it is not designed or manufactured for use in applications that require safety critical functions (e.g. aircraft, automobiles, combustion equipment, life support systems, nuclear reactor control system, safety devices, spacecraft, submarine repeaters, traffic control equipment, trains, vessels, etc.). If the LEDs are planned to be used for these applications, unless otherwise detailed in the specification, Nichia will neither guarantee that the LED is fit for that purpose nor be responsible for any resulting property damage, injuries and/or loss of life/health. This LED does not comply with ISO/TS 16949 and is not intended for automotive applications.
- The customer will not reverse engineer, disassemble or otherwise attempt to extract knowledge/design information from the LED.
- All copyrights and other intellectual property rights in this specification in any form are reserved by Nichia or the right holders who have granted Nichia permission to use the content. Without prior written permission from Nichia, no part of this specification may be reproduced in any form or by any means.
- Both the customer and Nichia will agree on the official specifications for the supplied LEDs before any programs are officially launched. Without this agreement in writing (i.e. Customer Specific Specification), changes to the content of this specification may occur without notice (e.g. changes to the foregoing specifications and appearance, discontinuation of the LEDs, etc.).